

Biotechnology Explorer™

CAPTIVATING SCIENCE EDUCATION

BIO-RAD

Professional Development

pGLO™ Transformation and Purification of Green Fluorescent Protein (GFP)

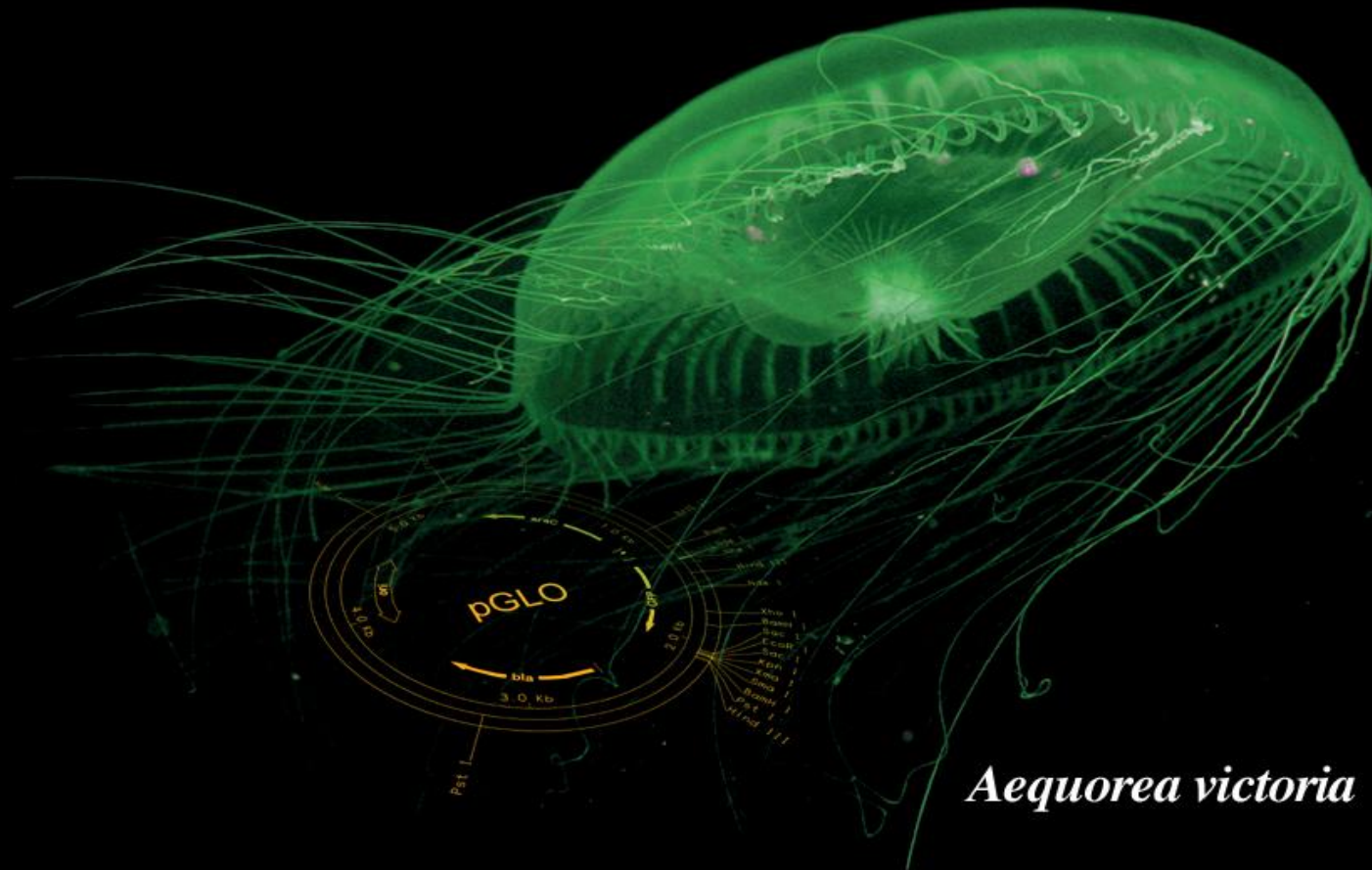

Aequorea victoria

Instructors

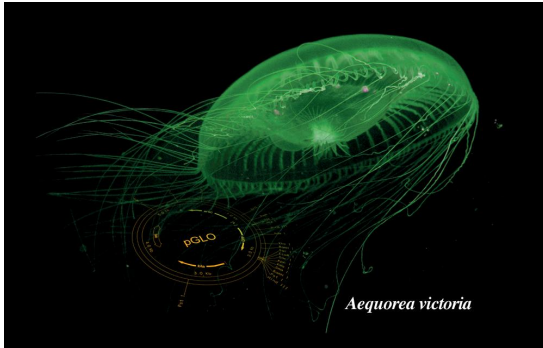

Stan Hitomi

Coordinator – Math & Science
San Ramon Valley Unified School District
Danville, CA

Kirk Brown

Lead Instructor, Edward Teller Education Center
Science Chair, Tracy High School
and Delta College, Tracy, CA

Sherri Andrews, Ph.D.

Curriculum and Training Specialist
Bio-Rad Laboratories

Essy Levy, M.Sc.

Curriculum and Training Specialist
Bio-Rad Laboratories

Why Teach

Bacterial Transformation and Protein Purification?

- **Powerful teaching tool**
- **Laboratory extensions**
- **Real-world connections**
- **Link to careers and industry**
- **Standards based**



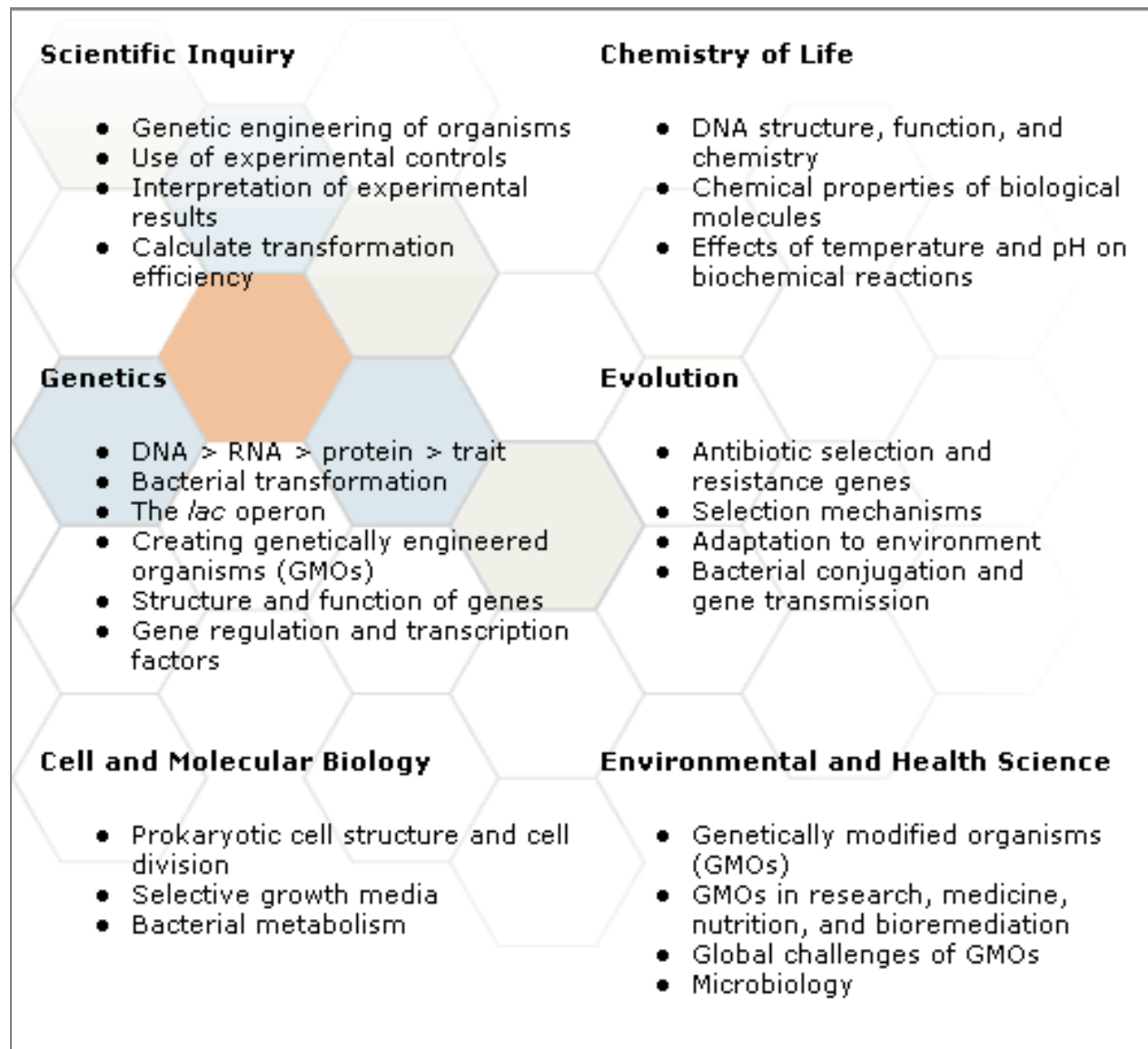

pGLO™ Bacterial Transformation Kit

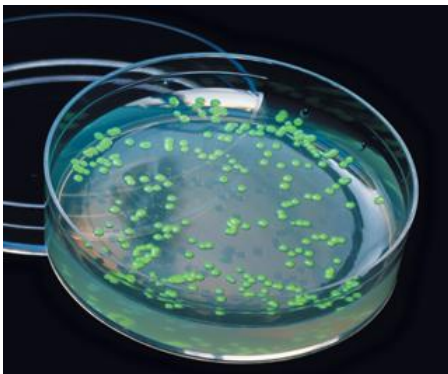

Bio-Rad pGLO Kit Advantages

- **Standards-based**
- **Comprehensive curricula for inquiry-based investigations**
- **Compatible with 50 minute class periods**
- **Serves entire class of 32 students (up to 4 students per group)**
- **Cost-effective**
- **Success in student's hands**
- **Safe**
- **Striking results!**

Green Fluorescent Protein (GFP) Chromatography Kit

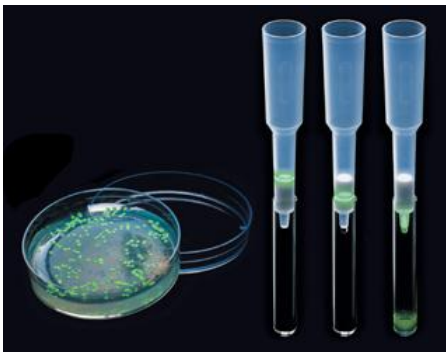

GFP Purification Kit Advantages

- **Cloning in action**
- **Links to biomanufacturing**
- **Biopharmaceutical development**
- **Amazing visual results**



EasyPack Column

GelTec Column

Workshop Time Line

- **Introduction**
- **Transform bacteria with pGLO plasmid**
- **Purify GFP using column chromatography**

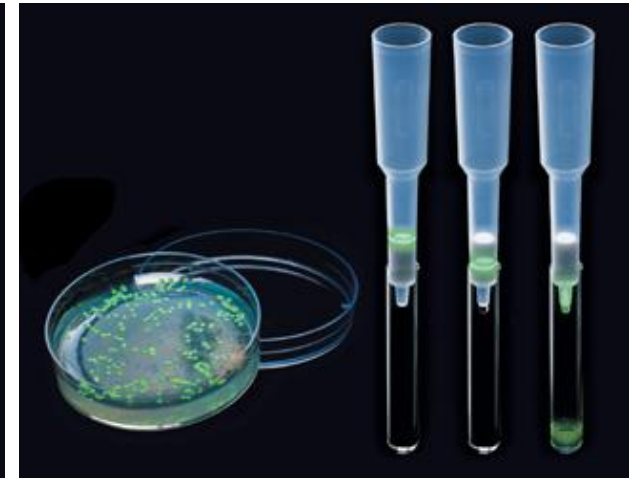
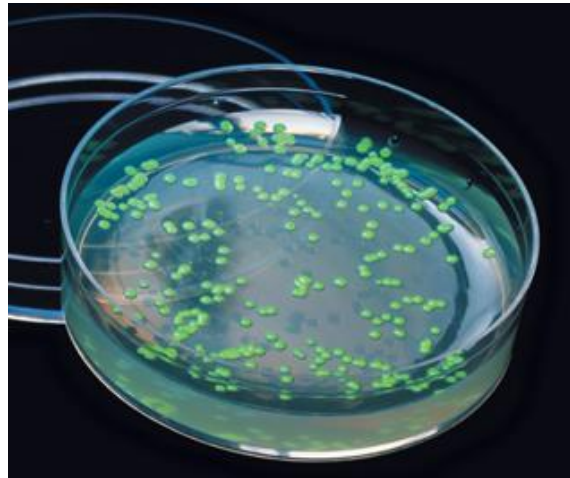

Central Framework of Molecular Biology

DNA → **RNA** → **Protein** → **Trait**



```
graph LR; DNA --> RNA; RNA --> Protein; Protein --> Trait
```

Links to Real-world



- **GFP is a visual marker**
- **Study of biological processes**
(example: synthesis of proteins)
- **Localization and regulation of gene expression**
- **Cell movement**
- **Cell fate during development**
- **Formation of different organs**
- **Screenable marker to identify transgenic organisms**

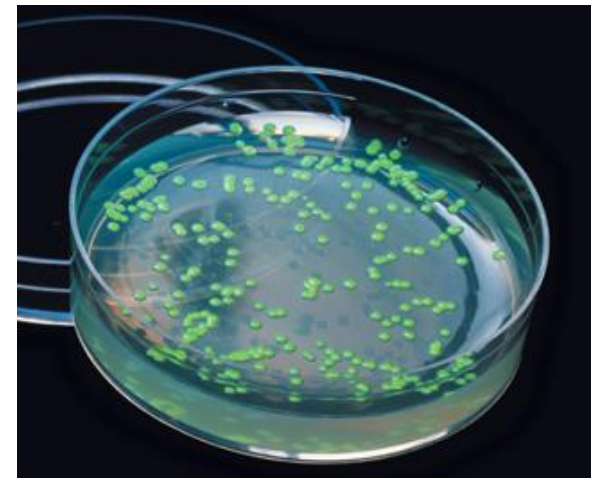
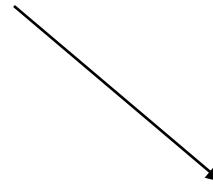
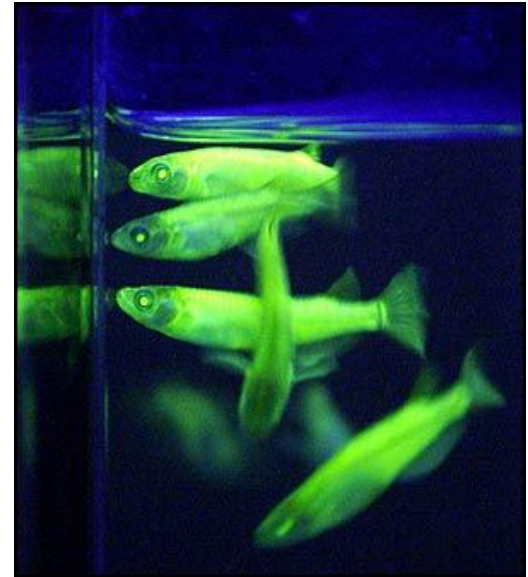
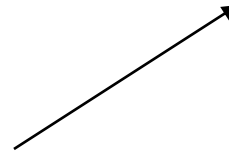
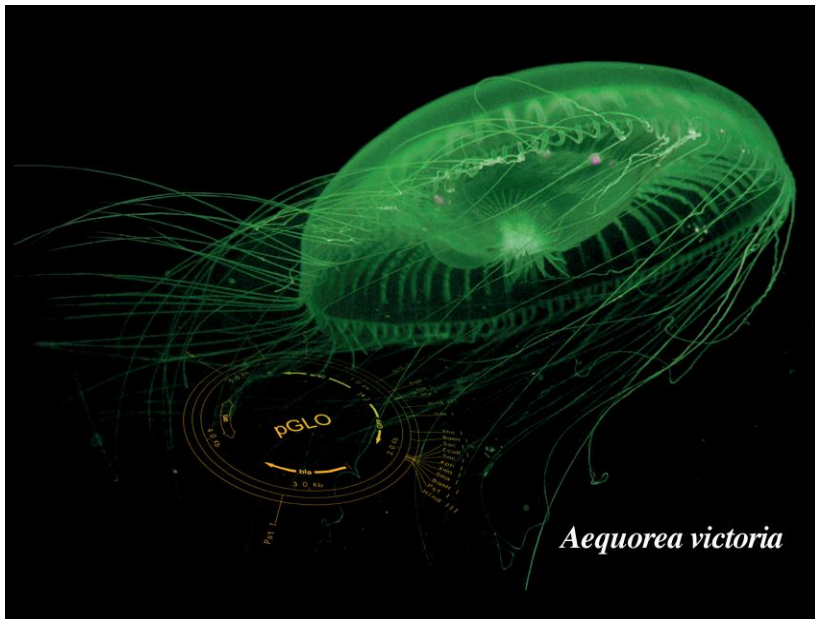

Using GFP as a biological tracer

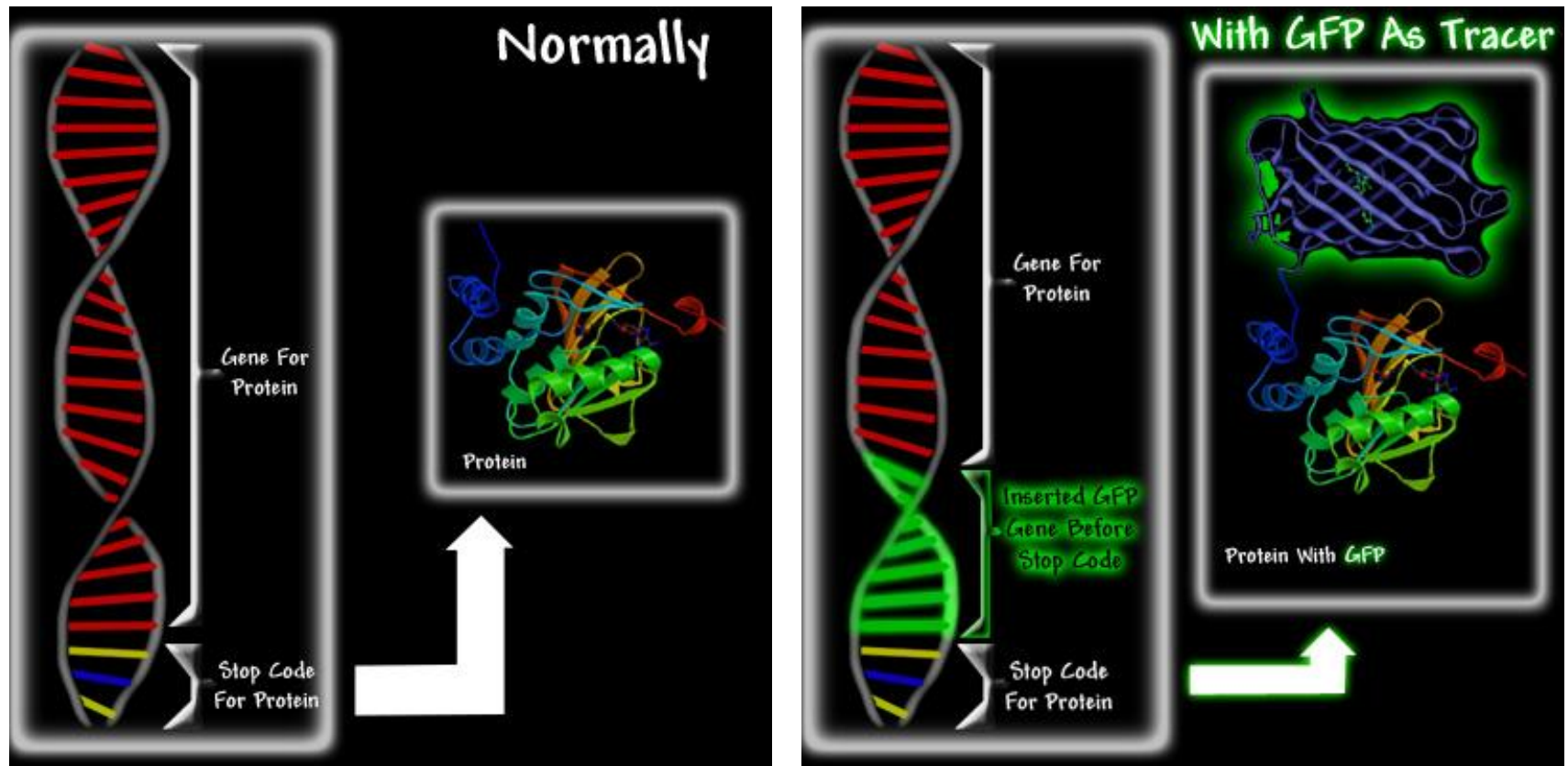

<http://www.conncoll.edu/ccacad/zimmer/GFP-ww/prasher.html>

With permission from Marc Zimmer

Transformation Procedure Overview

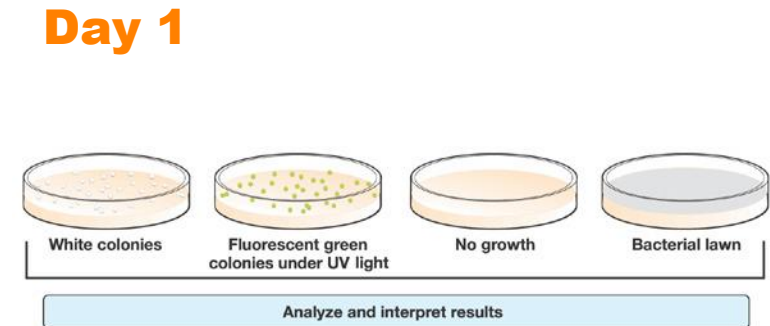
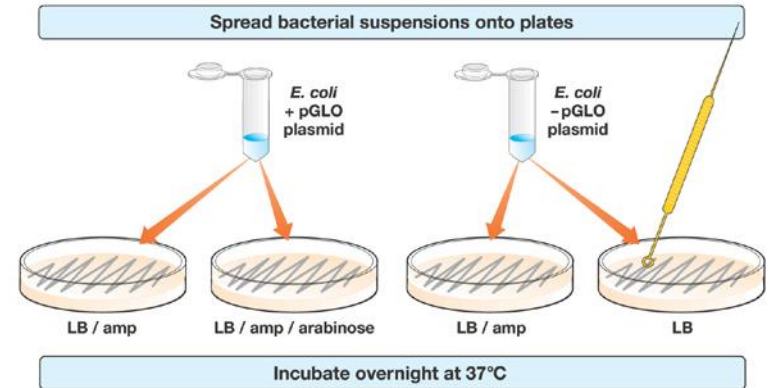
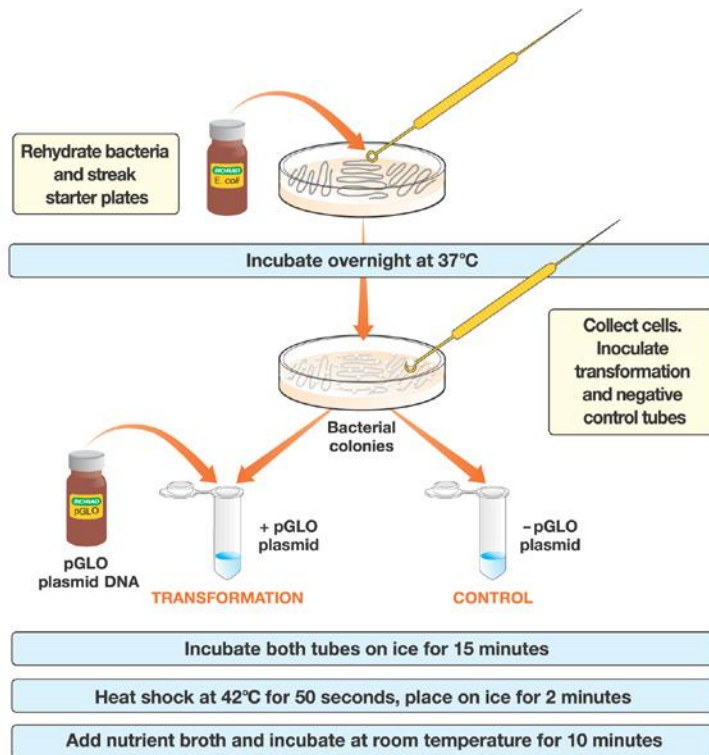

Day 2

Extension: GFP chromatography kit, pp. 22–23

What is Transformation?

- **Uptake of foreign DNA**, often a circular plasmid

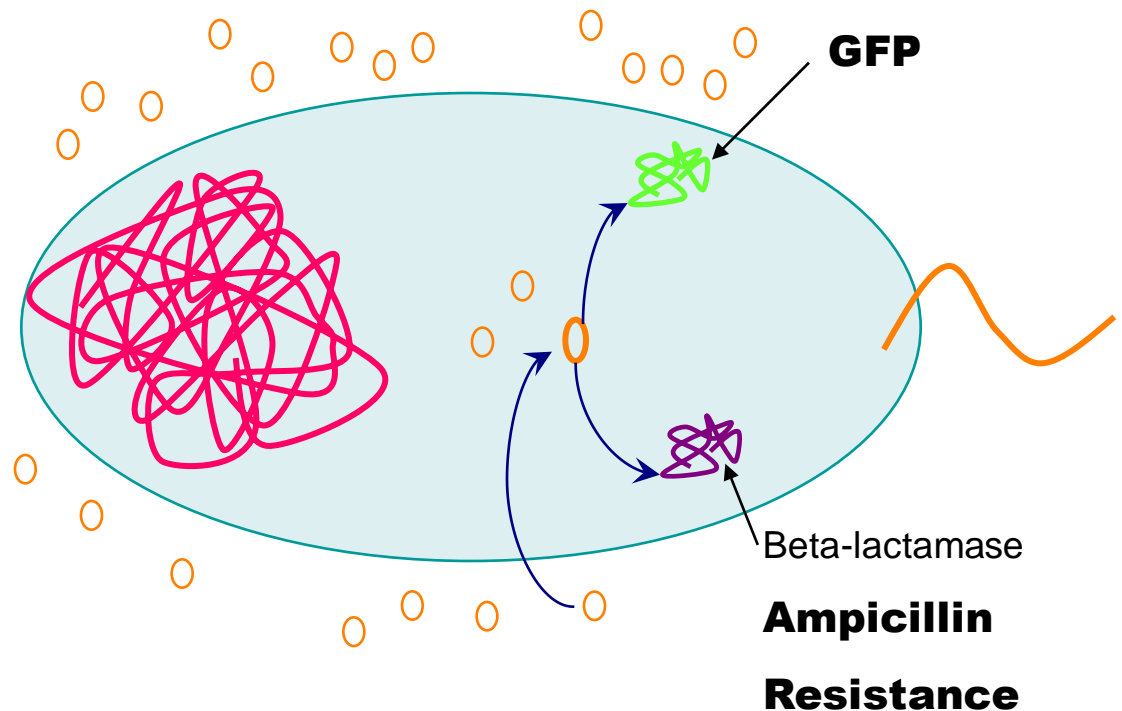

What is a plasmid?

- **A circular piece of autonomously replicating DNA**
- **Originally evolved by bacteria**
- **May express antibiotic resistance gene or be modified to express proteins of interest**

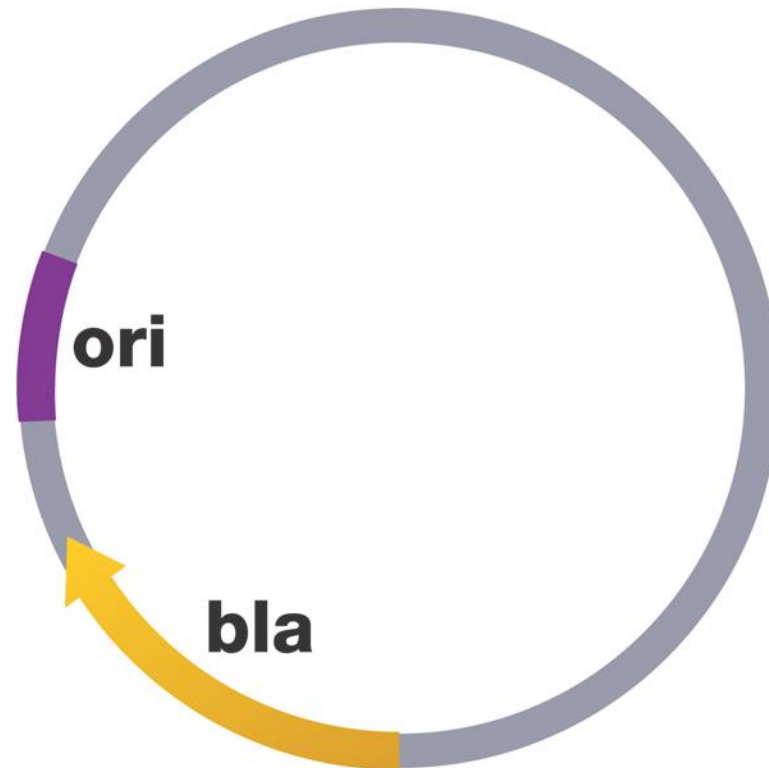

Bacterial DNA

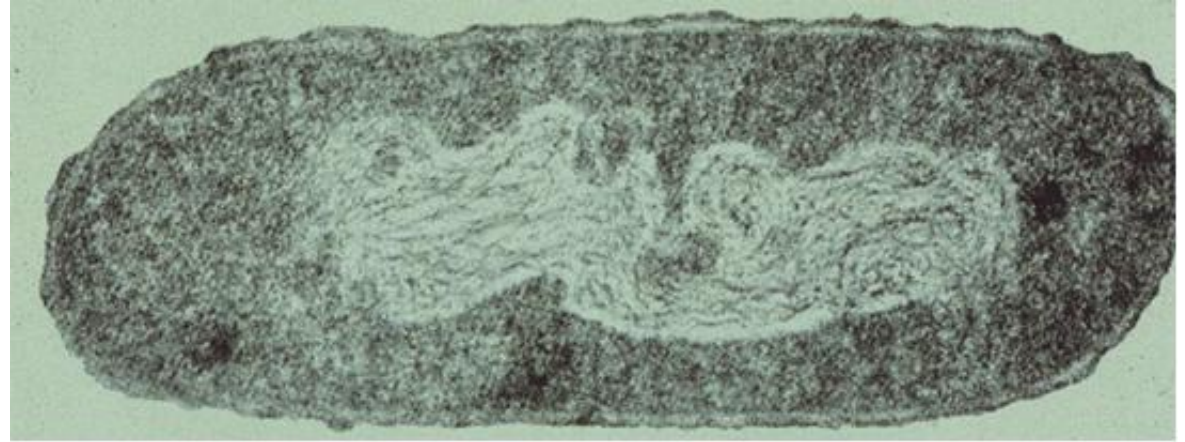

Bacterial cell

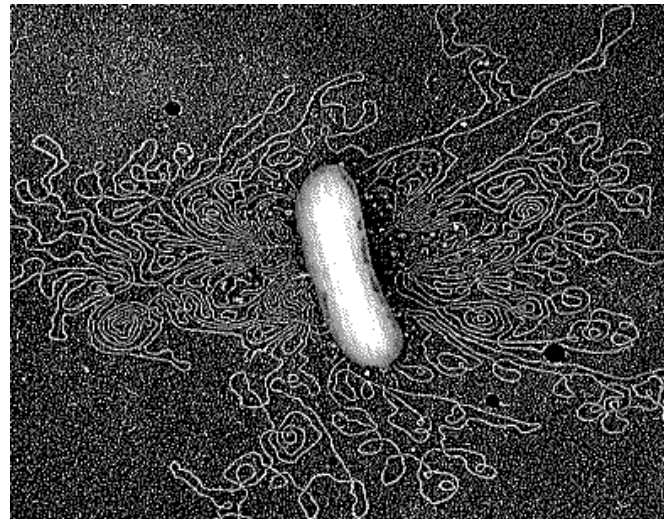

Genomic DNA



Plasmid DNA ●

The Many Faces of Plasmids

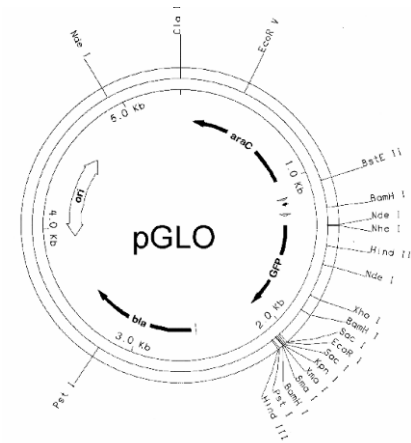

Graphic representation



Scanning electron micrograph of supercoiled plasmid

Gene Expression

- **Beta Lactamase**
– Ampicillin resistance
- **Green Fluorescent Protein (GFP)**
– *Aequorea victoria* jellyfish gene
- **araC regulator protein**
– Regulates GFP transcription

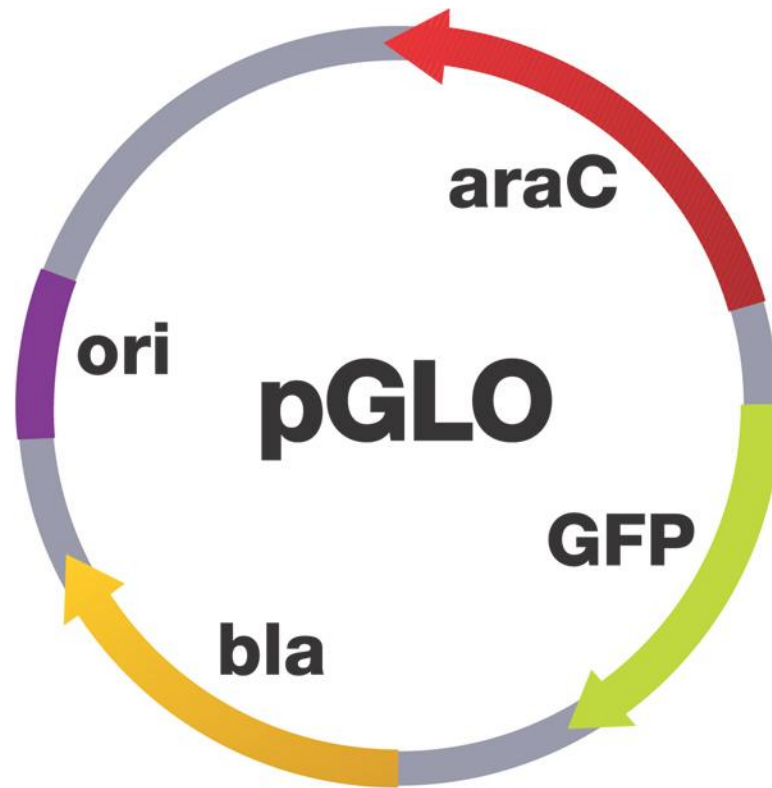

Bacterial Transformation

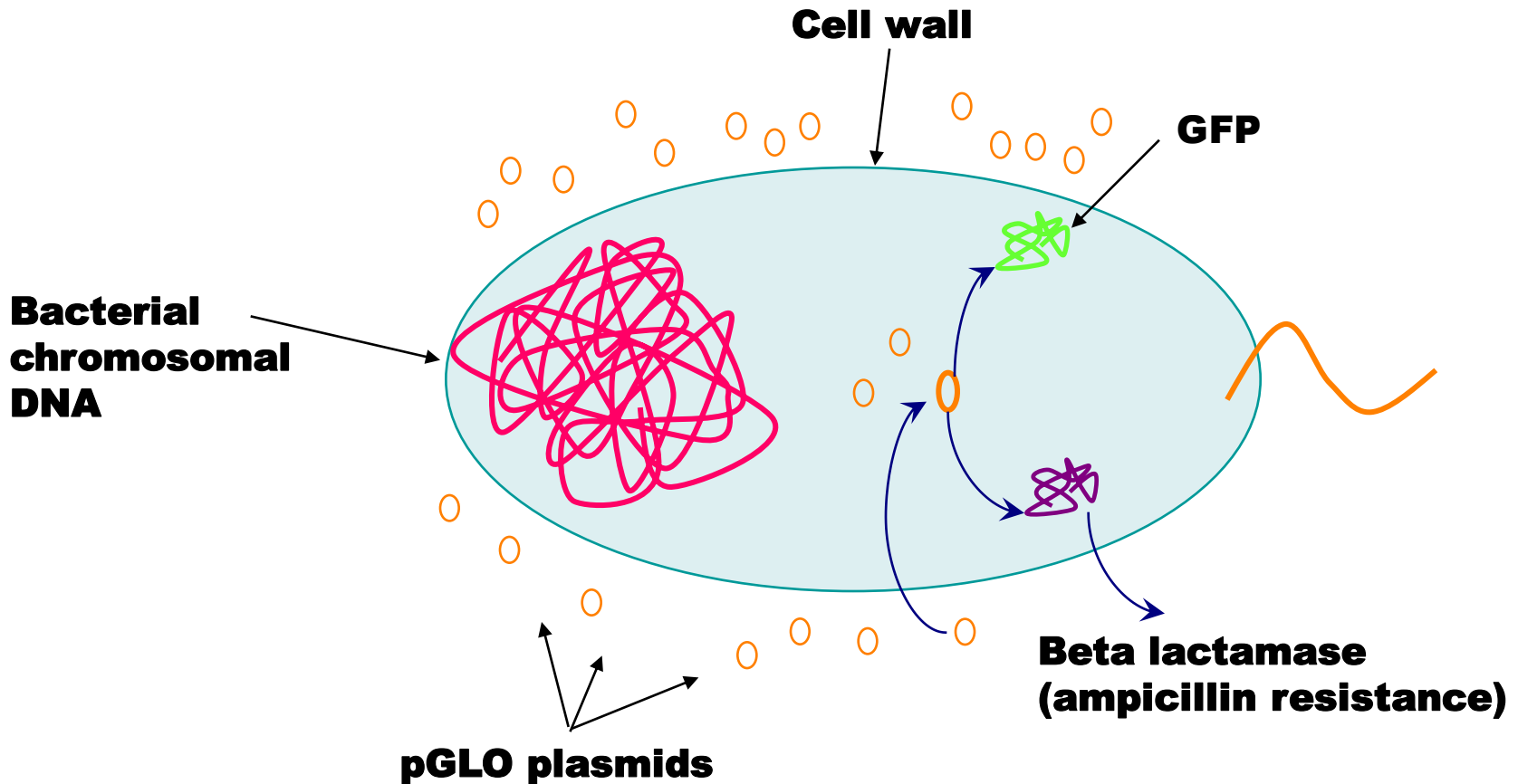

Transcriptional Regulation

- Lactose operon
- Arabinose operon
- pGLO plasmid

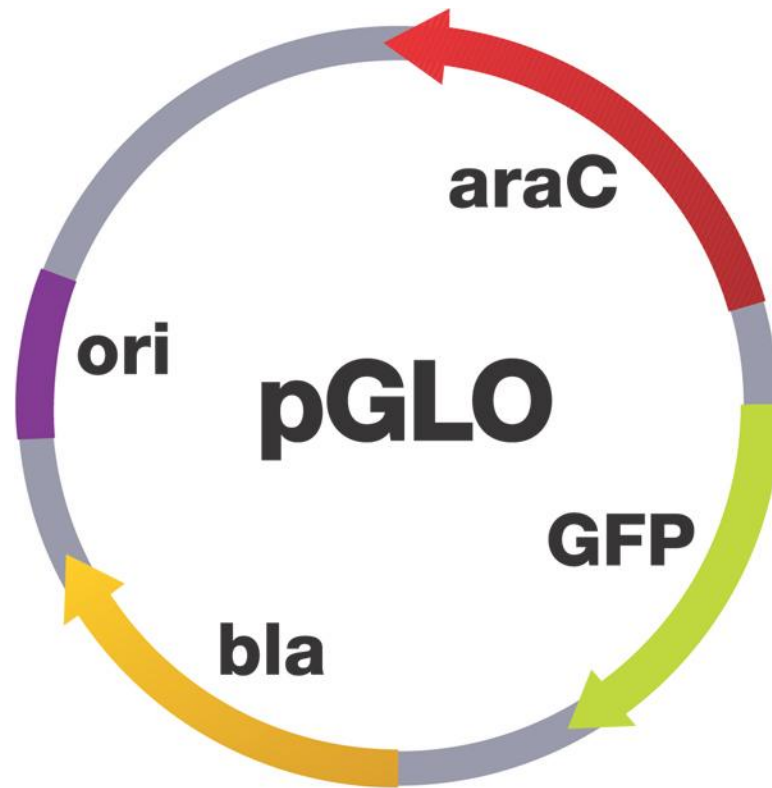

Transcriptional Regulation

lac Operon

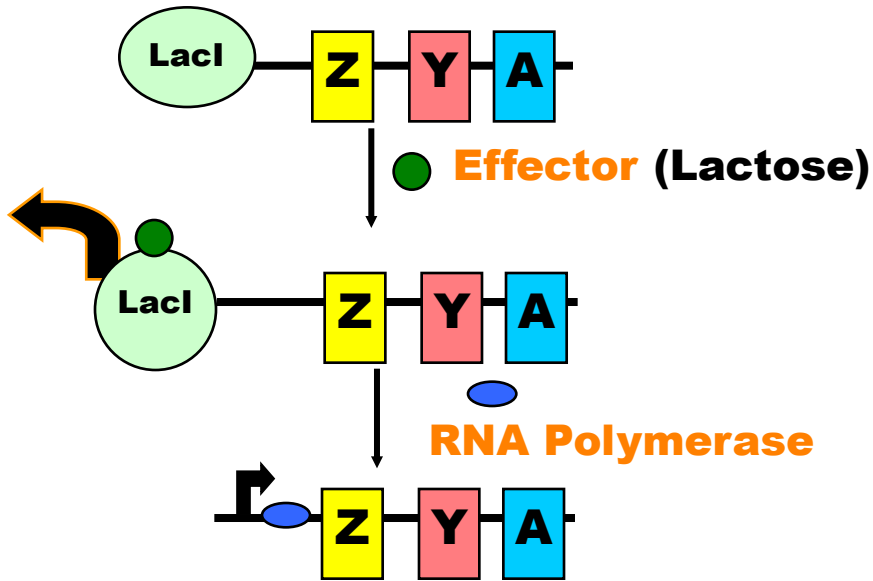

ara Operon

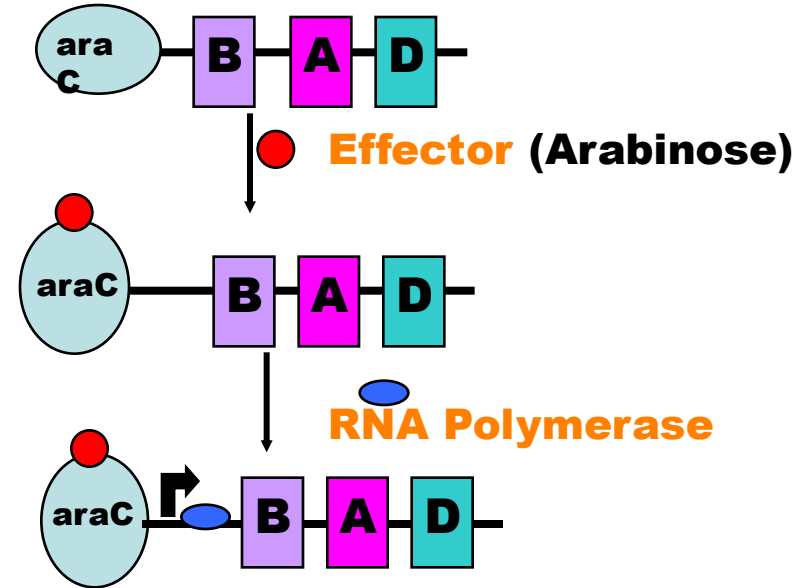

Gene Regulation

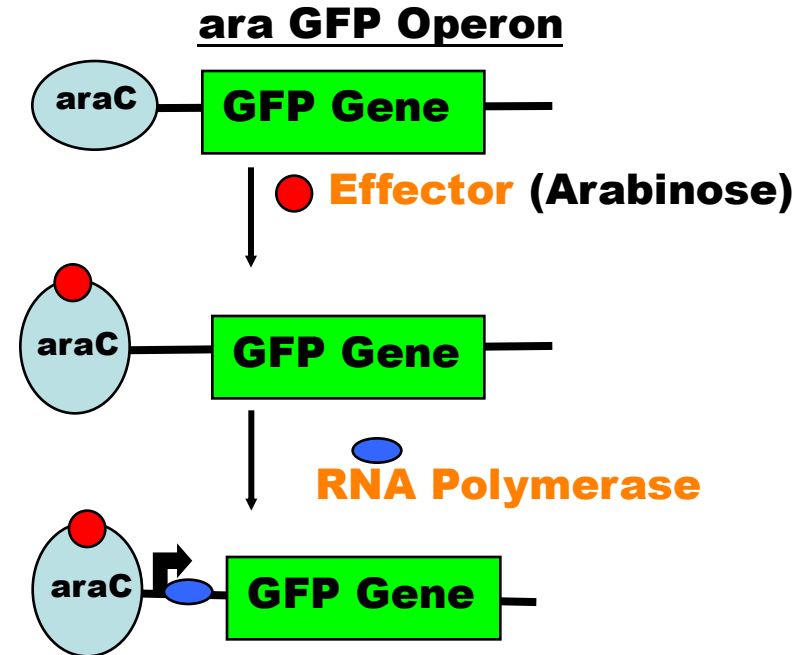
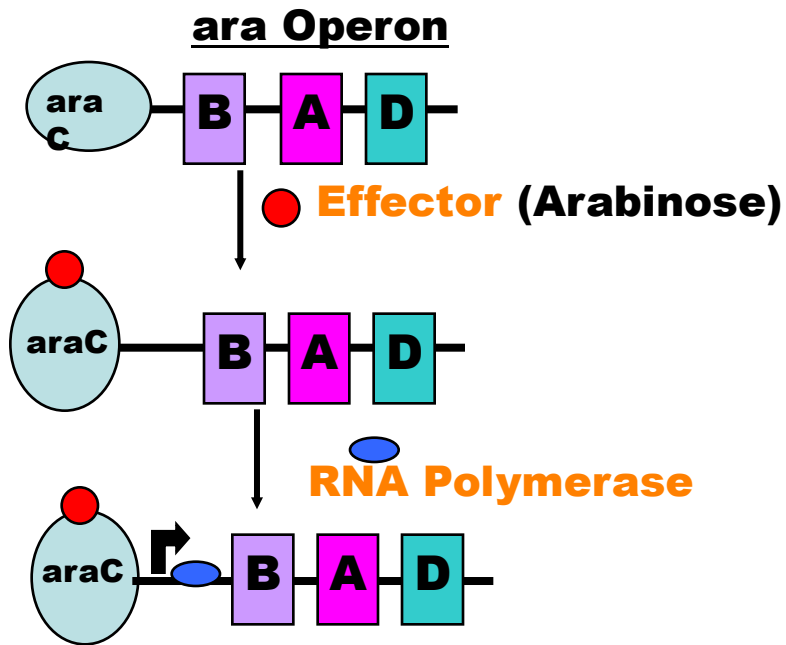

Methods of Transformation

- **Electroporation**
 - Electrical shock makes cell membranes permeable to DNA
- **Calcium Chloride/Heat-Shock**
 - Chemically-competent cells uptake DNA after heat shock

Transformation Procedure

- **Suspend bacterial colonies in Transformation solution**
- **Add pGLO plasmid DNA**
- **Place tubes on ice**
- **Heat-shock at 42°C and place on ice**
- **Incubate with nutrient broth**
- **Streak plates**

Reasons for Performing Each Transformation Step?

1. Transformation solution = CaCl_2

Positive charge of Ca^{++} ions shields negative charge of DNA phosphates

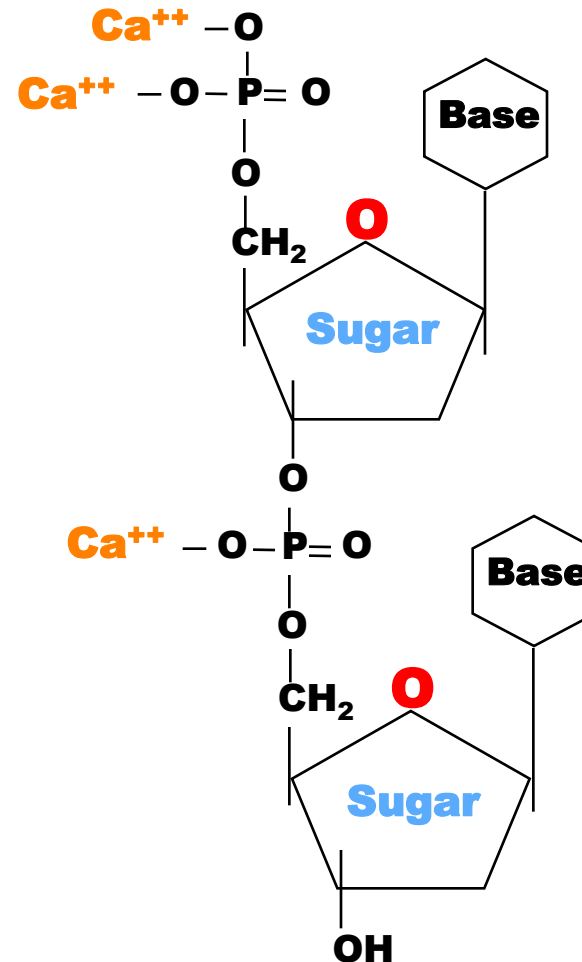

Why Perform Each Transformation Step?

2. Incubate on ice

slows fluid cell membrane

3. Heat-shock

Increases permeability of membranes

4. Nutrient broth incubation

Allows beta-lactamase expression

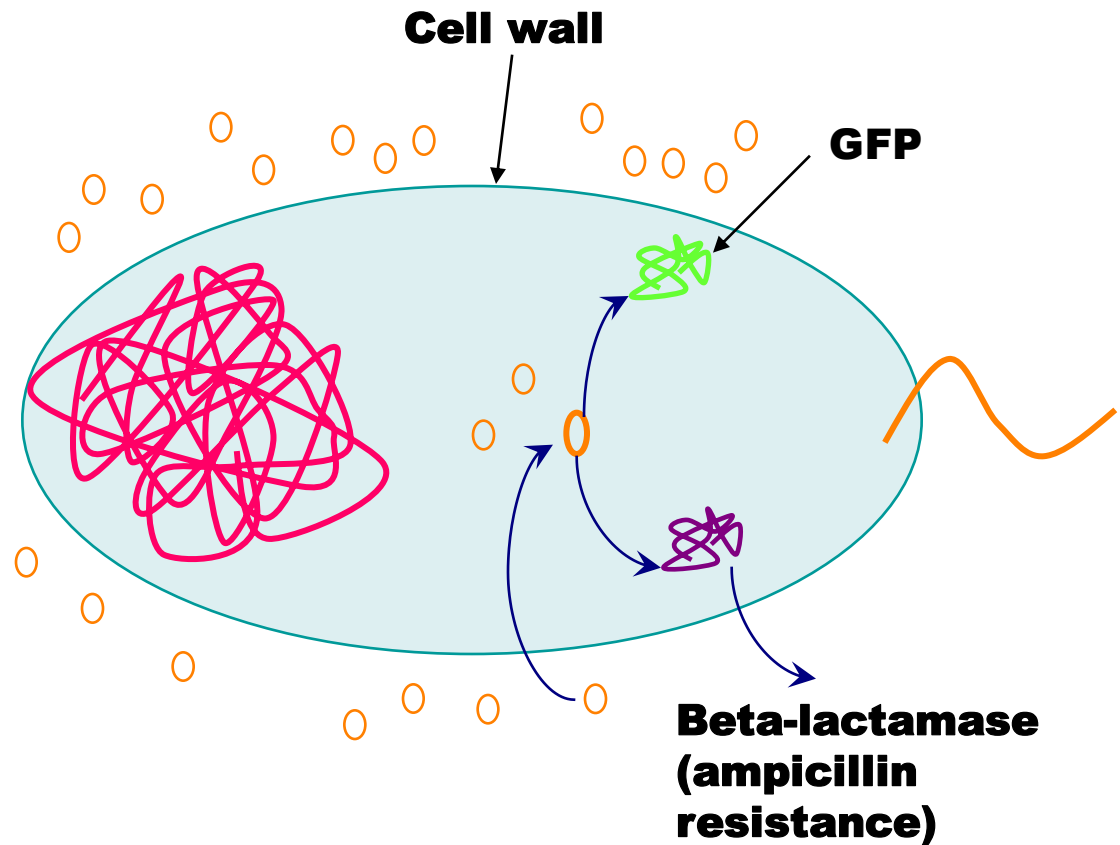

What is Nutrient Broth?



- **Luria-Bertani (LB) broth**
- **Medium that contains nutrients for bacterial growth and gene expression**
 - Carbohydrates
 - Amino acids
 - Nucleotides
 - Salts
 - Vitamins

Grow? Glow?

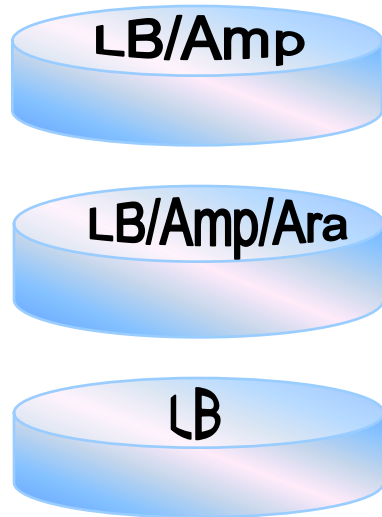

- Follow protocol
- On which plates will colonies **grow**?
- Which colonies will **glow**?

Laboratory Quick Guide

Transformation Kit—Quick Guide

1. Label one closed micro test tube +pGLO and another -pGLO. Label both tubes with your group's name. Place them in the foam tube rack.



2. Open the tubes and using a sterile transfer pipet, transfer 250 µl of transformation solution (CaCl₂).



3. Place the tubes on ice.



4. Use a sterile loop to pick up a single colony of bacteria from your starter plate. Pick up the +pGLO tube and immerse the loop into the transformation solution at the bottom of the tube. Spin the loop between your index finger and thumb until the entire colony is dispersed in the transformation solution (with no floating clumps). Place the tube back in the tube rack in the ice. Using a new sterile loop, repeat for the -pGLO tube.



5. Examine the pGLO plasmid DNA solution with the UV lamp. Note your observations. Immerse a new sterile loop into the plasmid DNA stock tube. Withdraw a loopful. There should be a film of plasmid solution across the ring. This is similar to seeing a soapy film across a ring for blowing soap bubbles. Mix the loopful into the cell suspension of the +pGLO tube. Close the tube and return it to the rack on ice. Also close the -pGLO tube. Do not add plasmid DNA to the -pGLO tube. Why not?



6. Incubate the tubes on ice for 10 minutes. Make sure to push the tubes all the way down in the rack so the bottom of the tubes stick out and make contact with the ice.

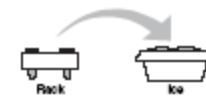

GFP Electrophoresis Extension

- **SDS PAGE** sample preps are made from white and green colonies
- **Bacterial lysates** are prepared in Laemmli buffer
- **Samples** are loaded onto polyacrylamide gels

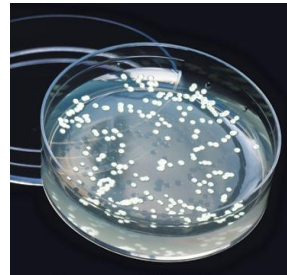

LB/amp

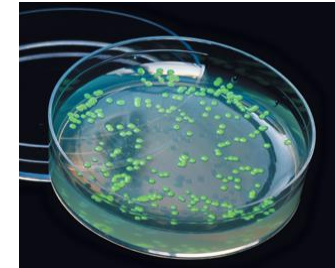
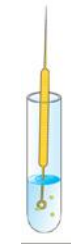
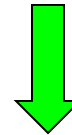
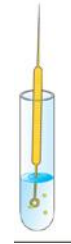

LB/amp/ara

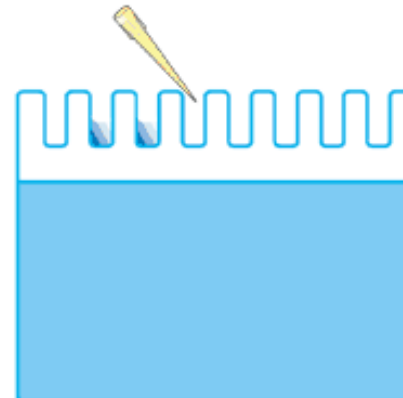

GFP Visualization- During & Post Electrophoresis

- Samples are electrophoresed
- Fluorescent GFP can be visualized during electrophoresis
- Coomassie stained gels allow for visualization of induced GFP proteins

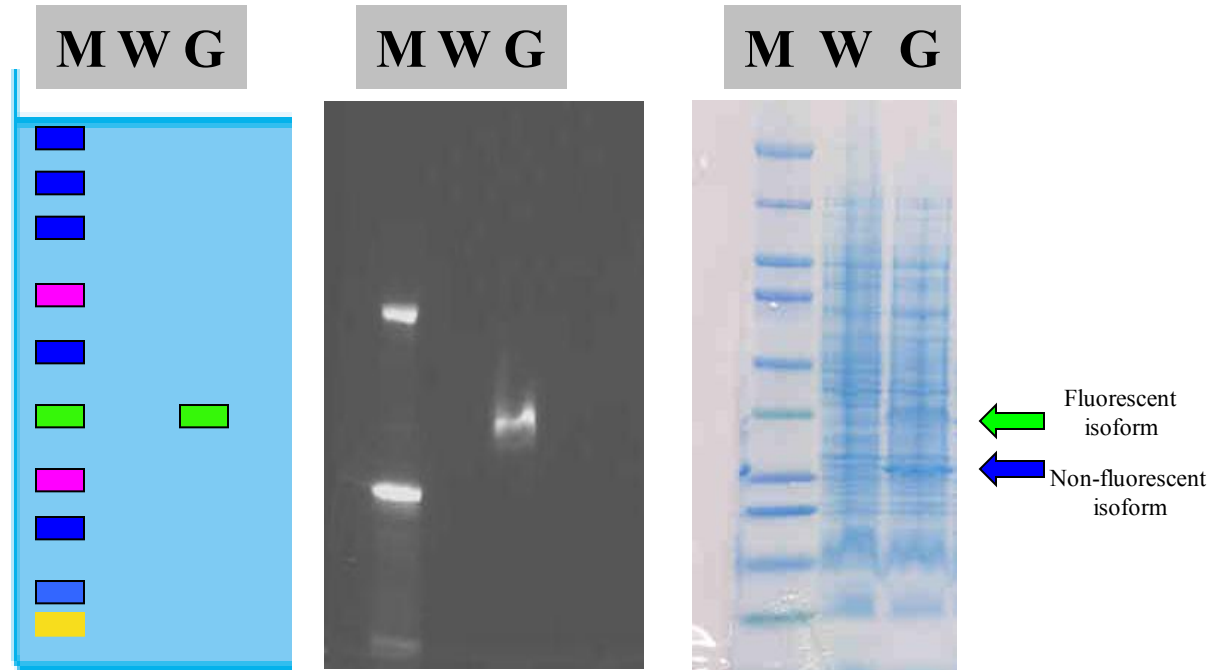

During Electrophoresis

Prestained bands
+ UV activated GFP

Fluorescent
bands

Post Electrophoresis

Coomassie stained
bands

Volume Measurement

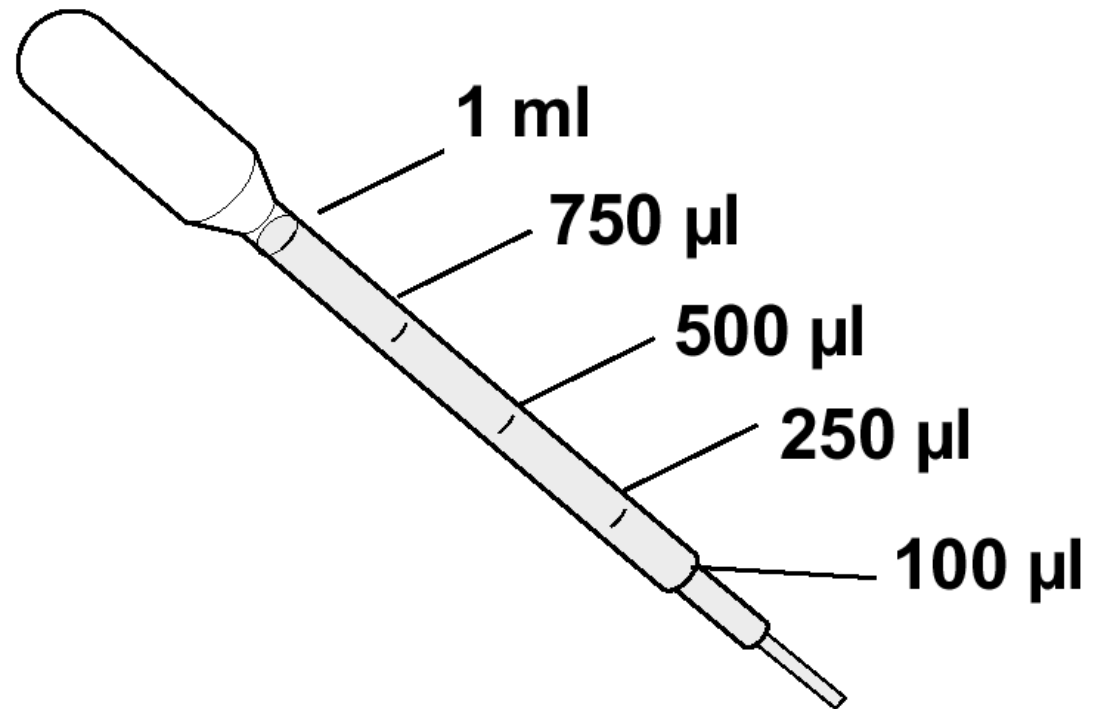

GFP Chromatography Kit

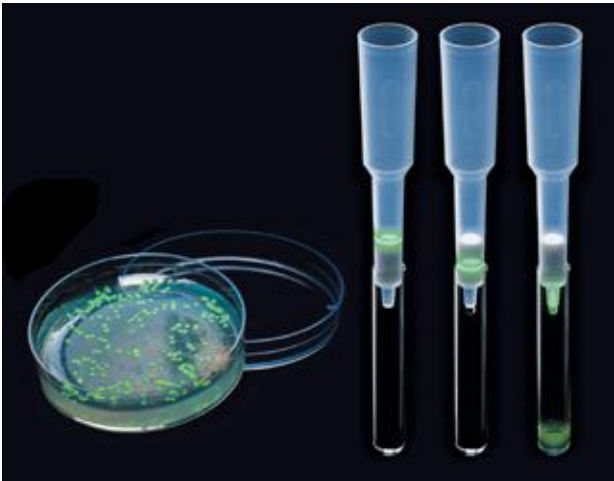

GFP Purification Procedures Overview

Start with bacterial colonies transformed with pGLO plasmid DNA

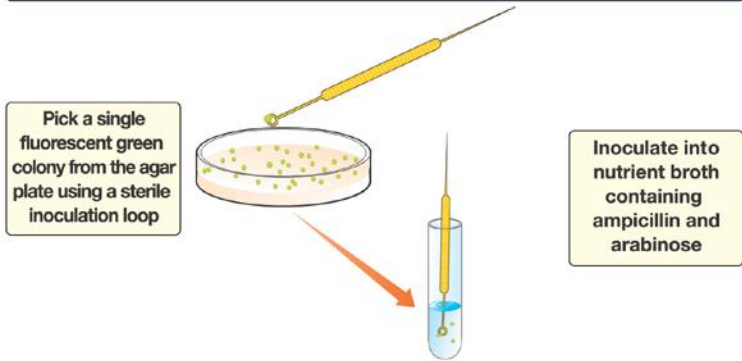

Grow overnight at 32°C or 2 days at room temperature with shaking

Day 1

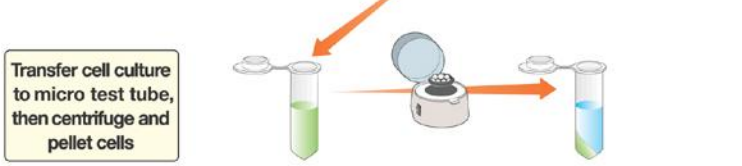

Day 2

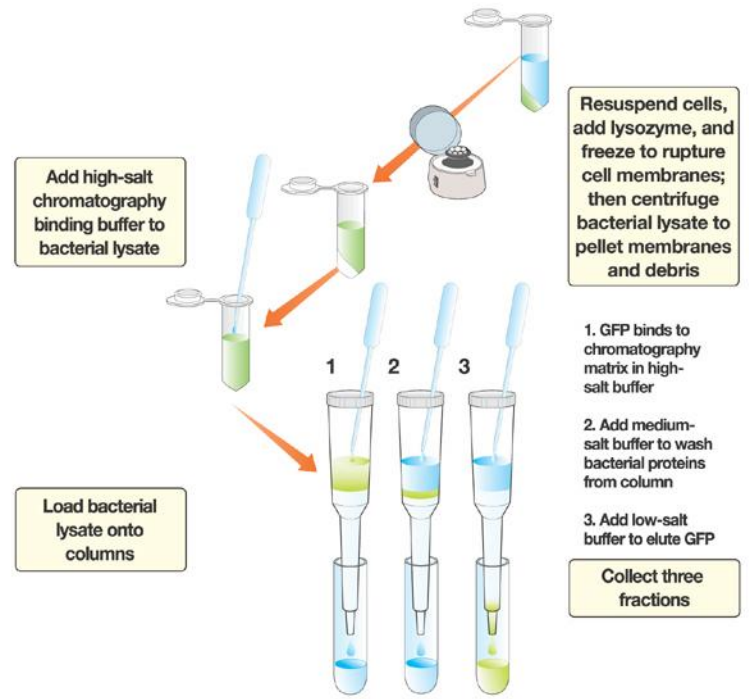

Separate GFP from bacterial proteins

Extension: Use protein gel electrophoresis to conduct quantitative and qualitative analysis of fractions

Day 3

Why Use Chromatography?

- To purify a single recombinant protein of interest from over 4,000 naturally occurring *E. coli* gene products.

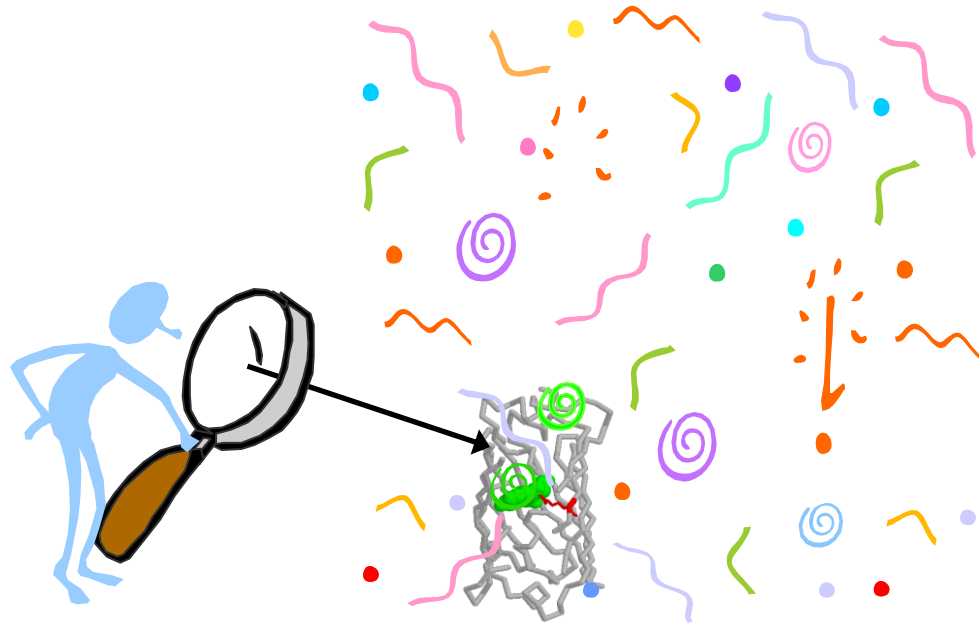

Column Chromatography

- **Chromatography used for protein purification**
 - Size exclusion
 - Ion exchange
 - **Hydrophobic interaction**

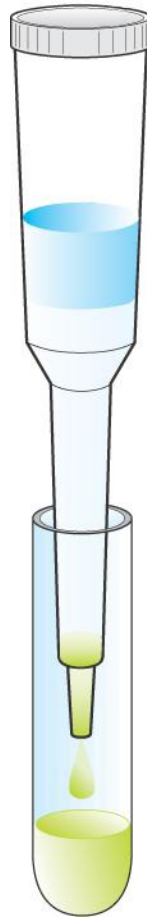

Hydrophobic Interaction Chromatography:

(HIC)

Steps 1–3

1. **Add** bacterial lysate to column matrix in **high salt buffer**
2. **Wash** less hydrophobic proteins from column in **low salt buffer**
3. **Elute** GFP from column with **no salt buffer**

Step 1: Hydrophobic Interaction Chromatography

- **Add bacterial lysate to column matrix in high salt buffer**

- Hydrophobic proteins interact with column
- Salt ions interact with the less hydrophobic proteins and H₂O

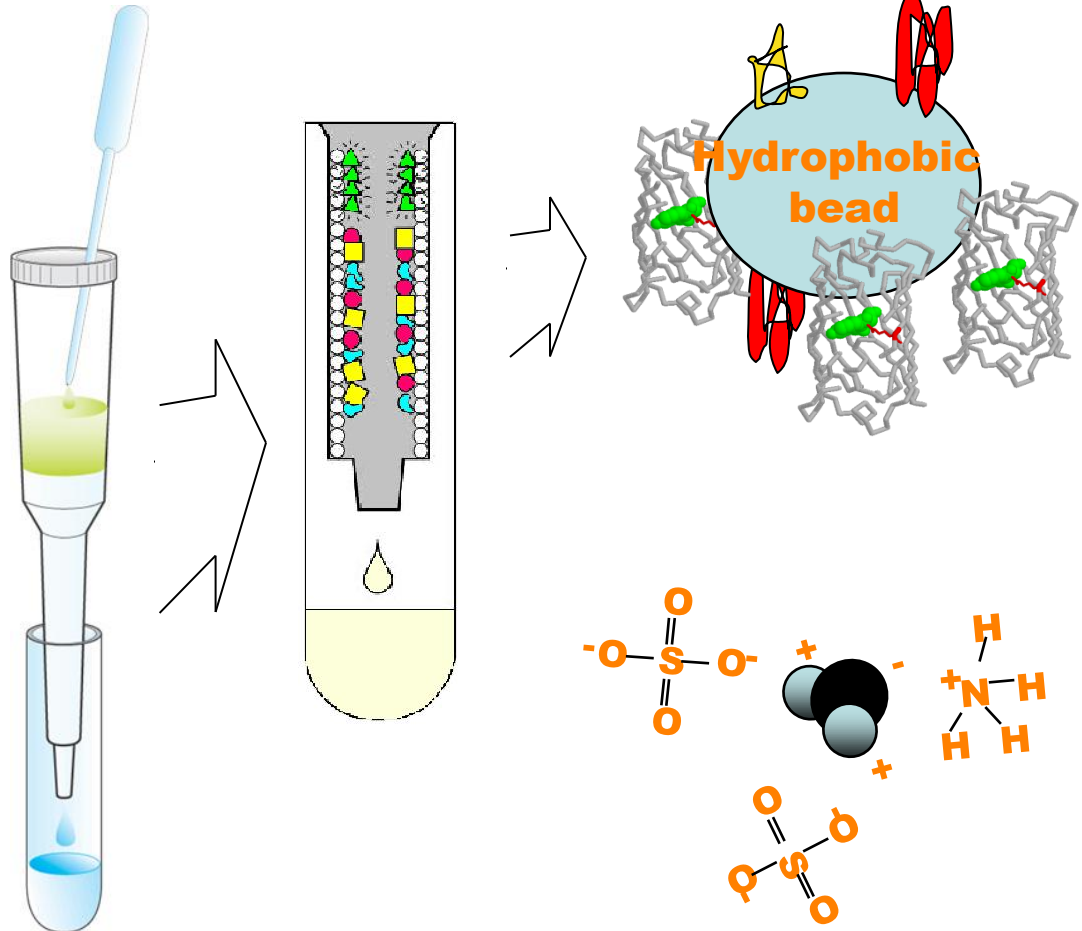
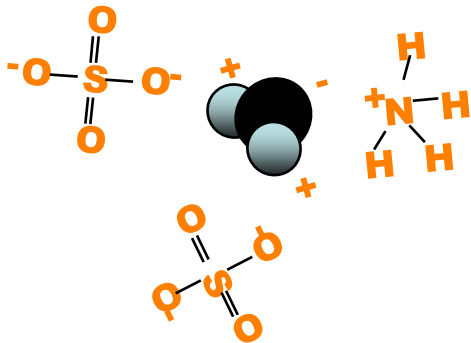

Step 2: Hydrophobic Interaction Chromatography

- **Wash less hydrophobic from column with low salt buffer**
 - Less hydrophobic E. coli proteins fall from column
 - GFP remains bound to the column

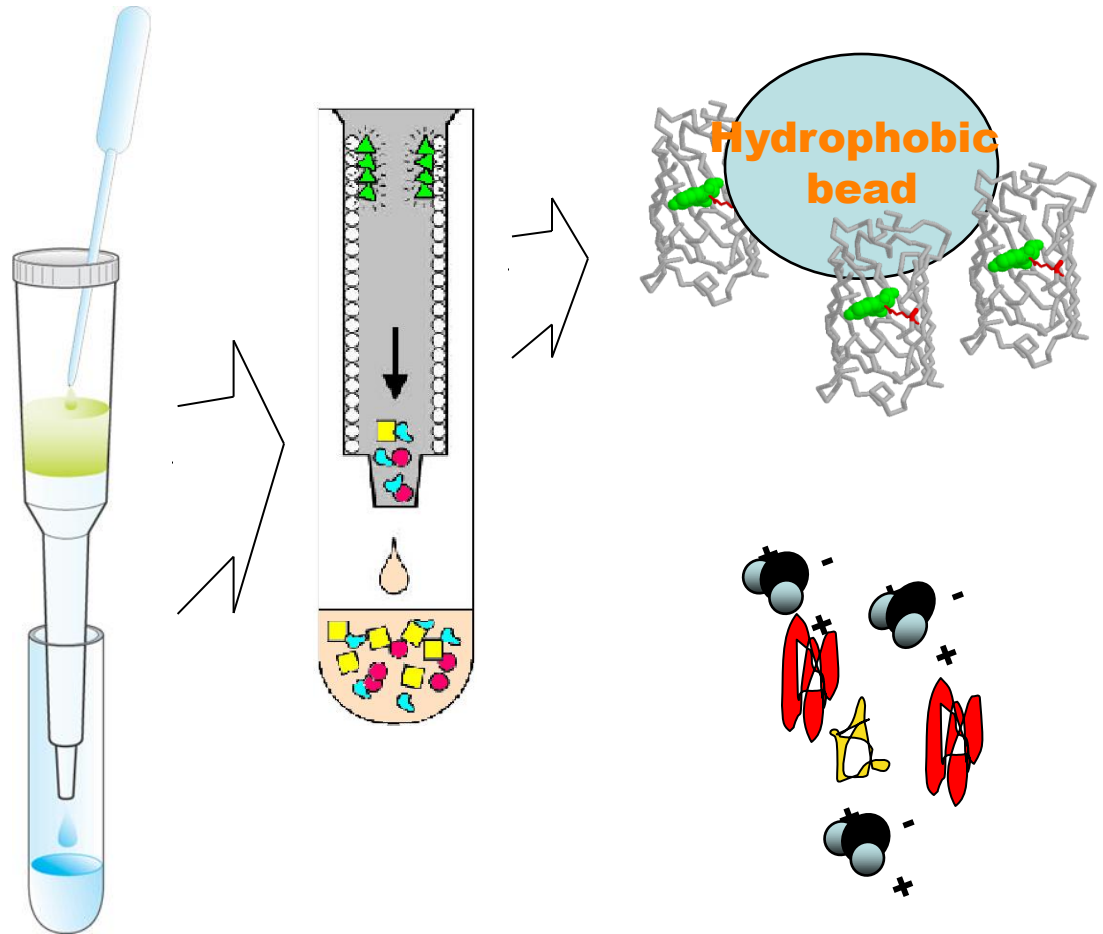
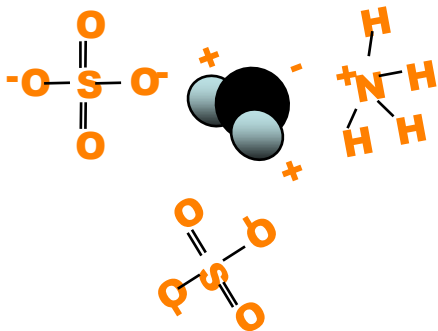

Step 3: Hydrophobic Interaction Chromatography

- Elute GFP from column by adding a no-salt buffer

GFP

- Released from column matrix
- Flows through the column

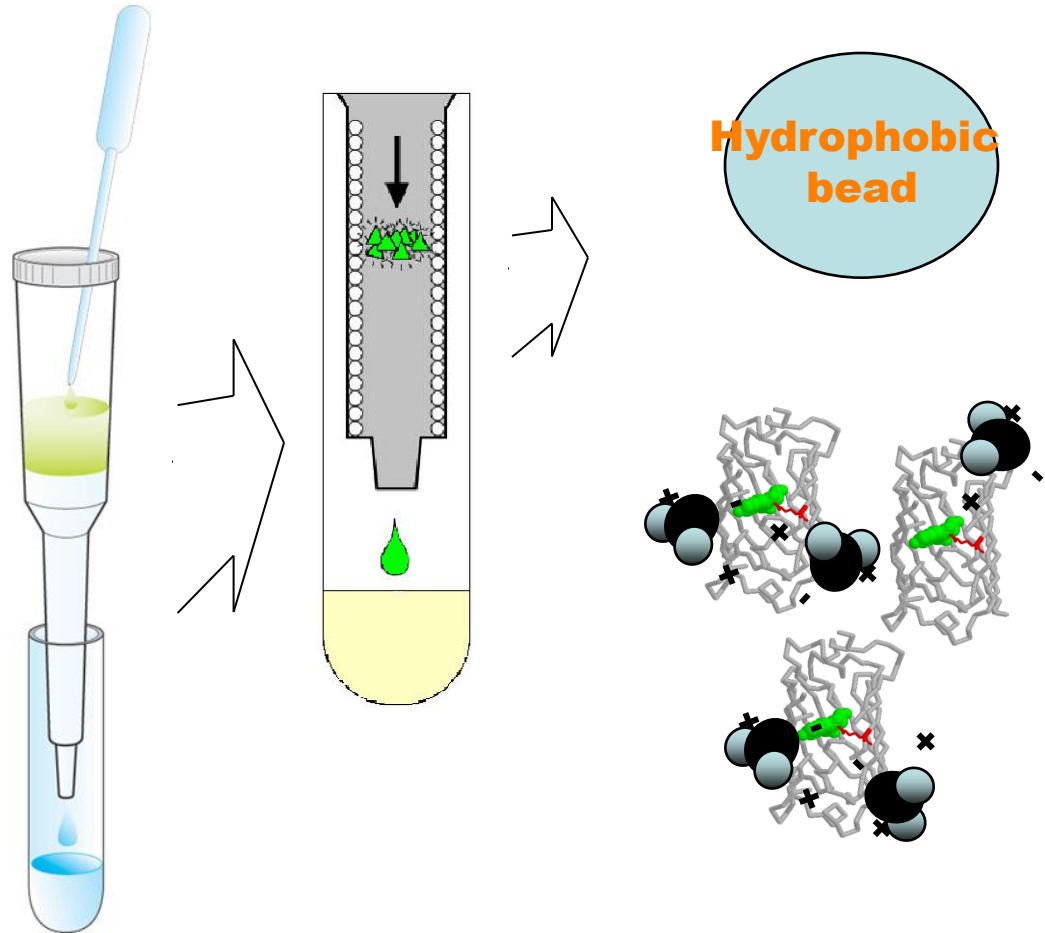

Laboratory Quick Guide

Lesson 5 Purification Phase 3

Protein Chromatography

1. Label 3 collection tubes 1–3 and place the tubes in the foam rack or in a rack supplied in your laboratory. Remove the caps from the top and bottom of the column and place the column in collection tube 1. When the last of the buffer has reached the surface of the HIC matrix proceed to the next step below.

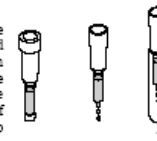

2. Using a new pipette, carefully and gently load 250 μ l of the “+” supernatant onto the top of the column. Hold the pipette tip against the side of the column wall, just above the upper surface of the matrix and let the supernatant drip down the side of the column wall. Examine the column using a UV light. Note your observations. After it stops dripping transfer the column to collection tube 2.

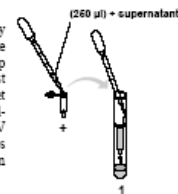

3. Using the rinsed pipette, add 250 μ l of wash buffer and let the entire volume flow into the column. Examine the column using the UV light. Note your observations. After the column stops dripping, transfer it to tube 3.

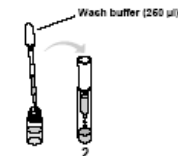

4. Using the rinsed pipette, add 750 μ l of TE Buffer and let the entire volume flow into the column. Examine the column using the UV light. Note your observations.

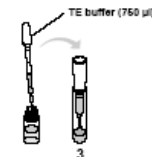

5. Examine all three collection tubes and note any differences in color between the tubes. Parafilm or Saran Wrap the tubes and place in the refrigerator until the next laboratory period.



Helpful Hints: Hydrophobic Interaction Chromatography

- **Add** a small piece of paper to collection tube where column seats to insure column flow



- **Rest** pipet tip on side of column to avoid column bed disturbance when adding solutions

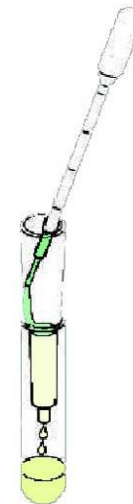

- **Drain** until the meniscus is **just** above the matrix for best separation

