

# XYZprinting 3D Scanner Quick Start Guide

## Main Component

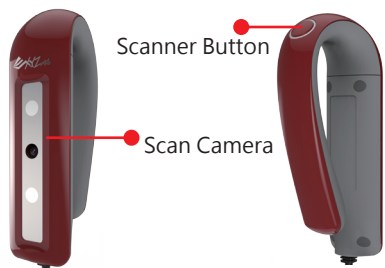

## System Requirements

Supported Operating System:  
Windows 8.1 and above (64-bit)

Minimum Hardware Requirements:  
4th Generation Intel® Core™ i5 Process (PC)  
USB 3.0  
4G RAM Basic (8G RAM Recommended)

Recommended Hardware:  
Graphics card:  
NVIDIA GeForce GTX 750 ti with 2GB VRAM or better (for desktops)  
NVIDIA GeForce GTX 840M with 2GB VRAM or better (for laptops)

## Scan Spec

Scan Resolution: 1.0-2.5mm  
Scan Volume:

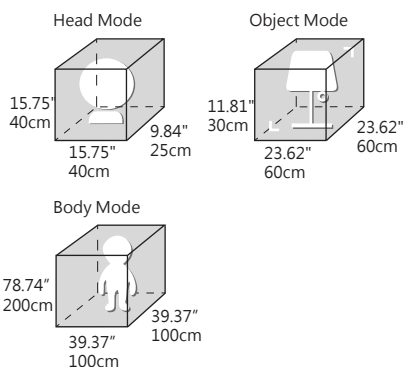

## Scan Tips

Reflective, metal, and transparent objects may be difficult for the scanner to capture. To scan objects with such features, you may apply rubber coating spray on the surface before scanning. When scanning a black or any dark colored object, please hold the scanner closer to the target and try to scan in different angles.

## Notice

Older, low-power CPU's may cause delays with scans.

## Before First Scan

① Sign in or register an account at XYZprinting website to get the latest information and instructions. You can even register your scanner to enjoy extended warranty on the product.



② Plug in the scanner into a USB 3.0 port on your device.

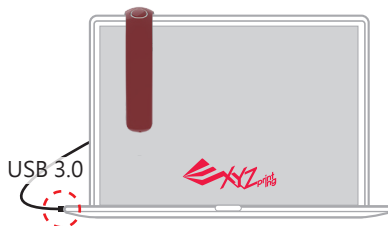

③ Find the bundled SD card in the package, and insert it into your computer. Run the "SETUP.exe" stored in the SD card, and install all required software and drivers.

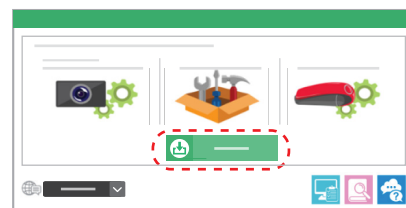

## Scanning with XYZscan Handy

After installing all required software, please launch XYZscan Handy on your device to scan.

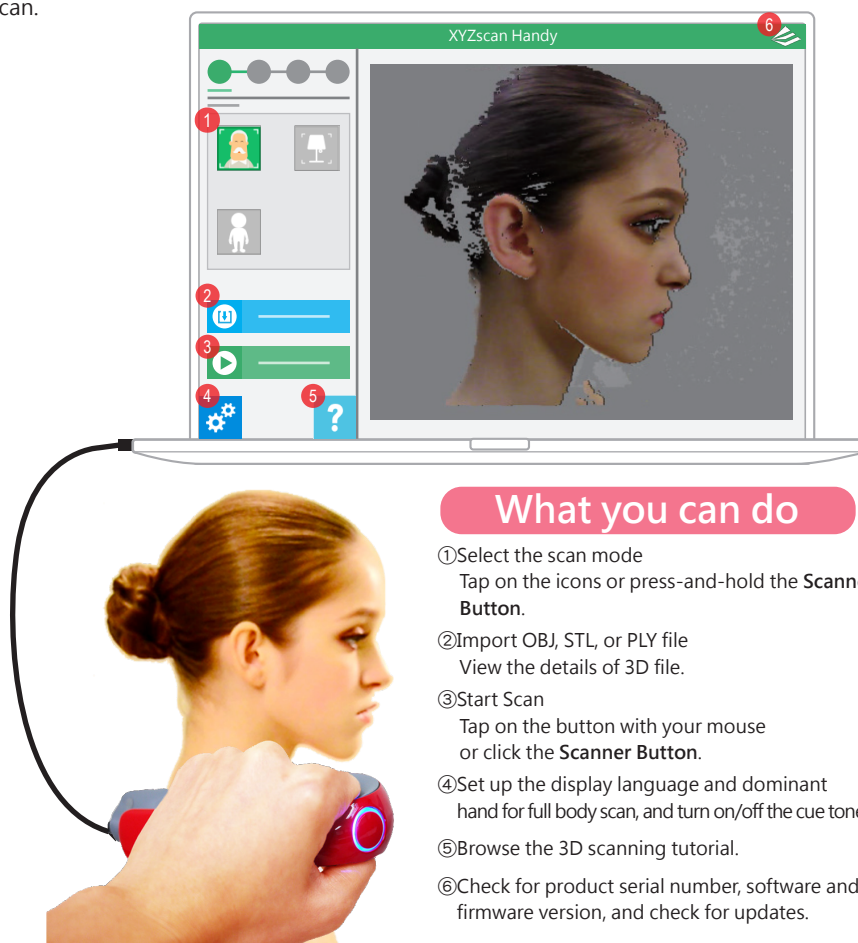

## What you can do

- ① Select the scan mode  
Tap on the icons or press-and-hold the **Scanner Button**.
- ② Import OBJ, STL, or PLY file  
View the details of 3D file.
- ③ Start Scan  
Tap on the button with your mouse or click the **Scanner Button**.
- ④ Set up the display language and dominant hand for full body scan, and turn on/off the cue tone.
- ⑤ Browse the 3D scanning tutorial.
- ⑥ Check for product serial number, software and firmware version, and check for updates.

## How to scan

- ① Select a scan mode based on the target.
- ② Tap on "Start Scan" or click the **Scanner Button**.
- ③ Move the scanner steadily to capture the images in different angles.
- ④ Tap on "Stop" or click the **Scanner Button**.

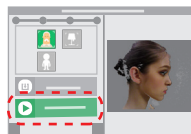
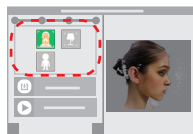

## Tutorials

- ① 3D Scanning Tutorial  
[http://wiki.xyzprinting.com/wordpress/about3dscan-us\\_en/](http://wiki.xyzprinting.com/wordpress/about3dscan-us_en/)
- ② Tutorial video  
[http://support.xyzprinting.com/us\\_en/Help/tutorial](http://support.xyzprinting.com/us_en/Help/tutorial)

