

Electron spin resonance at DPPH

Determining the magnetic field as a function of the resonance frequency

Objects of the experiment

- Determining the resonance magnetic field B_0 as function of the selected frequency ν .
- Determining the g -factor of DPPH.
- Determining the line width δB_0 of the resonance signal

Principles

Since its discovery by *E. K. Zavoisky* (1945), electron spin resonance (ESR) has developed into an important method of investigating molecular and crystal structures, chemical reactions and other problems in physics, chemistry, biology and medicine. It is based on the absorption of high-frequency radiation by paramagnetic substances in an external magnetic field in which the spin states of the electrons split.

Electron spin resonance is limited to paramagnetic substances because in these the orbital angular momenta and spins of the electrons are coupled in a way that the total angular momentum is different from zero. Suitable compounds are, e.g., those which contain atoms whose inner shells are not complete (transition metals, rare earths), organic molecules (free radicals) which contain individual unpaired electrons or crystals with lattice vacancies in a paramagnetic state.

The magnetic moment associated with the total angular momentum \vec{J} is

$$\vec{\mu}_J = -g_J \cdot \frac{\mu_B}{\hbar} \cdot \vec{J} \quad (\text{I})$$

$$(\mu_B = \frac{\hbar \cdot e}{2 \cdot m_e}, \hbar = \frac{h}{2\pi}, \mu_B: \text{Bohr magneton},$$

h : Planck constant, g_J : Landé splitting factor, m_e : mass of the electron, e : electronic charge)

In a magnetic field \vec{B}_0 , the magnetic moment $\vec{\mu}_J$ gets the potential energy

$$E = -\vec{\mu}_J \cdot \vec{B}_0 \quad (\text{II})$$

E is quantized because the magnetic moment and the total angular momentum can only take discrete orientations relative to the magnetic field. Each orientation of the angular momentum corresponds to a state with a particular potential energy in the magnetic field. The component J_z of the total angular momentum, which is parallel to the magnetic field, is given by

$$J_z = \hbar \cdot m_J \text{ with } m_J = -J, -(J-1), \dots, J \quad (\text{III})$$

where the angular momentum quantum number is an integer or a half-integer, i.e. the potential energy splits into the discrete *Zeeman* levels

$$E = g_J \cdot \mu_B \cdot B_0 \cdot m_J \text{ with } m_J = -J, -(J-1), \dots, J \quad (\text{IV})$$

The energy splitting can be measured directly by means of electron spin resonance. For this a high-frequency alternating magnetic field

$$\vec{B}_1 = \vec{B}_{\text{HF}} \cdot \sin(2\pi\nu \cdot t)$$

which is perpendicular to the static magnetic field \vec{B}_0 is radiated into the sample. If the energy $h \cdot \nu$ of the alternating field is equal to the energy difference ΔE between two neighbouring energy levels, i.e., if the conditions

$$\Delta m_J = \pm 1 \quad (\text{V})$$

and

$$h \cdot \nu = \Delta E = g_J \cdot \mu_B \cdot B_0 \quad (\text{VI})$$

are fulfilled, the alternating field leads to a "flip" of the magnetic moments from one orientation in the magnetic field B_0 into the other one. In other words, transitions between neighbouring levels are induced and a resonance effect is observed which shows up in the absorption of energy from the alternating magnetic field radiated into the sample.

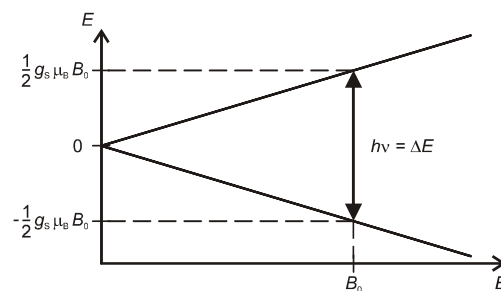

Fig. 1 Energy splitting of a free electron in a magnetic field and resonance condition for electron spin resonance.

In numerous compounds, orbital angular momentum is of little significance, and considerations can be limited to the spin of the electrons. To simplify matters, the situation is represented for a free electron in Fig. 1: here the total angular momentum is just the spin \vec{s} of the electron. The angular momentum quantum number is

$$J = s = \frac{1}{2}$$

and the Landé factor is

$$g_J = g_s \approx 2.0023.$$

In a magnetic field, the energy of the electron splits into the two levels

$$E = g_s \cdot \mu_B \cdot B_0 \cdot m_s \quad \text{with } m_s = -\frac{1}{2}, \frac{1}{2} \quad (\text{IVa}),$$

which correspond to an antiparallel and a parallel orientation of the electron spin with respect to the magnetic field. In a transition between the two levels, the selection rule (V) is automatically fulfilled: in analogy to Eq. (VI), the resonance condition reads

$$h \cdot \nu = g_s \cdot \mu_B \cdot B_0 \quad (\text{VIa}).$$

If now the energy which is absorbed from the alternating field is measured at a fixed frequency ν as a function of the magnetic field B_0 , an absorption line with a half-width δB_0 is obtained. In the simplest case, this line width in a homogeneous magnetic field is an expression of the uncertainty δE of the transition. The uncertainty principle applies in the form

$$\delta E \cdot T \geq \frac{\hbar}{2} \quad (\text{VII}),$$

where T is the lifetime of the level. Because of Eq. (V),

$$\delta E = g \cdot \mu_B \cdot \delta B_0 \quad (\text{VIII}).$$

Thus the relation

$$\delta B_0 = \frac{\hbar}{2 \cdot g_J \cdot \mu_B \cdot T} \quad (\text{IX}).$$

does not depend on the frequency ν . In this experiment, the position and width of the absorption lines in the ESR spectrum of the sample under consideration are evaluated.

From the position, the Landé factor g_J of the sample is determined according to Eq. (VI). In the case of a free atom or ion, the Landé factor lies between $g_J = 1$ if the magnetism is entirely due to orbital angular momentum and $g_J \approx 2,0023$ if only spins contribute to the magnetism. However, in actual fact the paramagnetic centres studied by means of electron spin resonance are not free. As they are inserted into crystal lattices or surrounded by a solvation sheath in a solution, they are subject to strong electric and magnetic fields, which are generated by the surrounding atoms. These fields lead to an energy shift and influence the *Zeeman* splitting of the electrons. Thereby the value of the g -factor is changed. It frequently becomes anisotropic, and a fine structure occurs in the ESR spectra. Therefore the g -factor allows conclusions to be drawn regarding electron binding and the chemical structure of the sample under consideration.

From the line width, dynamic properties can be inferred. If unresolved fine structures are neglected, the line width is determined by several processes which are opposed to an alignment of the magnetic moments. The interaction between aligned magnetic moments among each other is called spin-spin relaxation, and the interaction between the magnetic moments and fluctuating electric and magnetic fields, which are caused by lattice oscillations in solids and by thermal motion of the atoms in liquids, is called spin-lattice relaxation.

In some cases, the line width is influenced by so-called exchange interaction and is then much smaller than one would expect if there were pure dipole-dipole interaction of the spins.

ESR spectrometers developed for practical applications usually work at frequencies of about 10 GHz (microwaves, X band). Correspondingly, the magnetic fields are of the order of magnitude of 0.1 to 1 T. In this experiment, the magnetic field B_0 is considerably weaker. It is generated by means of the Helmholtz coils and can be adjusted to values between 0 and 4 mT by appropriate choice of the coil current. A current which is modulated with 50 Hz is superimposed on the constant coil current. The magnetic field B , which is correspondingly modulated, is thus composed of an equidirectional field B_0 and a 50-Hz field B_{mod} . The sample is located in an HF coil which is part of a high-duty oscillating circuit. The oscillating circuit is excited by a variable frequency HF oscillator with frequencies between 15 and 130 MHz.

If the resonance condition (V) is fulfilled, the sample absorbs energy and the oscillating circuit is loaded. As a result, the impedance of the oscillating circuit changes and the voltage at the coil decreases. This voltage is converted into the measuring signal by rectification and amplification.

The measuring signal reaches the output of the control unit with a time delay relative to the modulated magnetic field. The time delay can be compensated as a phase shift in the control unit. A two-channel oscilloscope in X-Y operation displays the measuring signal together with a voltage that is proportional to the magnetic field as a resonance signal. The resonance signal is symmetric if the equidirectional field B_0 fulfils the resonance condition and if the phase shift φ between the measuring signal and the modulated magnetic field is compensated (see Fig. 2).

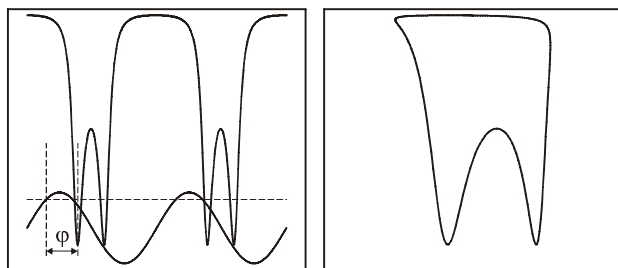

2a

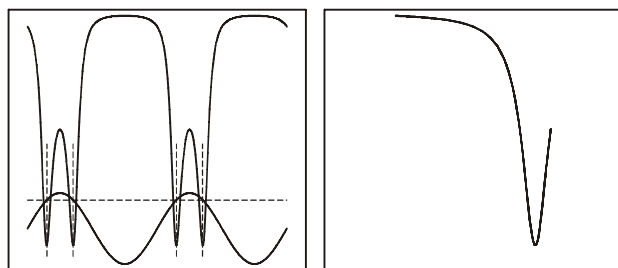

2b

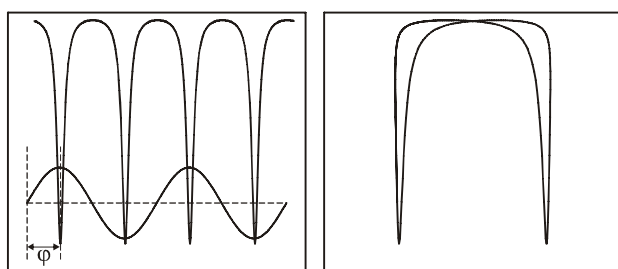

2c

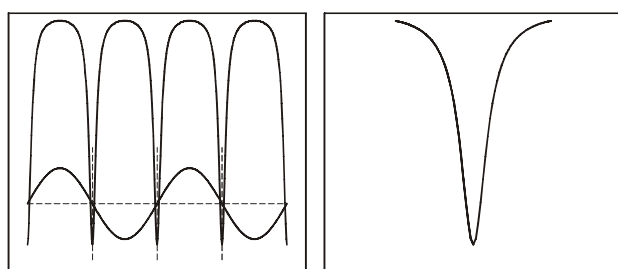

2d

Fig. 2 Oscilloscope display of the measuring signal (Y or I, respectively) and the modulated magnetic field (X or II, respectively)

left: two-channel display with DC coupled channel II
right: XY display with AC coupled channel II

Fig. 2a phase shift ϕ not compensated, equidirectional field B_0 too weak

Fig. 2b phase shift ϕ compensated, equidirectional field B_0 too weak

Fig. 2c phase shift ϕ not compensated, appropriate equidirectional field B_0

Fig. 2d phase shift ϕ compensated, appropriate equidirectional field B_0

The sample substance used is 1,1-diphenyl-2-picryl-hydrazyl (DPPH). This organic compound is a relatively stable free radical which has an unpaired valence electron at one atom of the nitrogen bridge (see Fig. 3). The orbital motion of the electron is almost cancelled by the molecular structure. Therefore the g -factor of the electron is almost equal to that of a free electron. In its polycrystalline form the substance is very well suited for demonstrating electron spin resonance because it has an intense ESR line, which, due to exchange narrowing, has a small width.

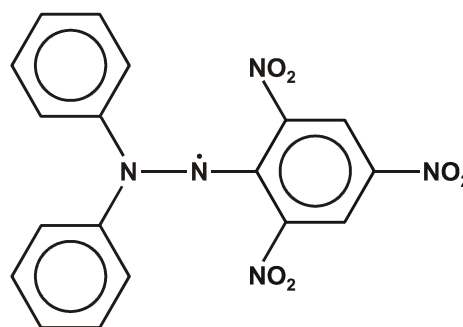

Fig. 3 Chemical structure of 1,1-diphenyl-2-picryl-hydrazyl (DPPH)

Apparatus

1 ESR basic unit	514 55
1 ESR control unit	514 571
1 pair of Helmholtz coils	555 604
1 two-channel oscilloscope 303	575 211
2 BNC cable 1m	501 02
3 saddle bases	300 11
1 connection lead 25 cm black	501 23
1 Connection lead 50 cm red	501 25
1 Connection lead 50 cm blue	501 26

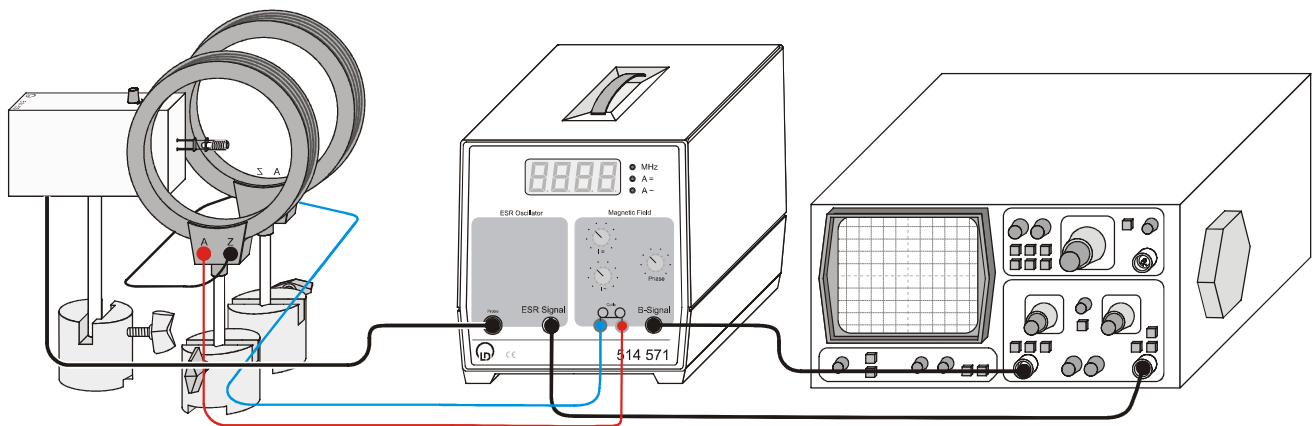

Fig. 4 Experimental setup for electron spin resonance at DPPH.

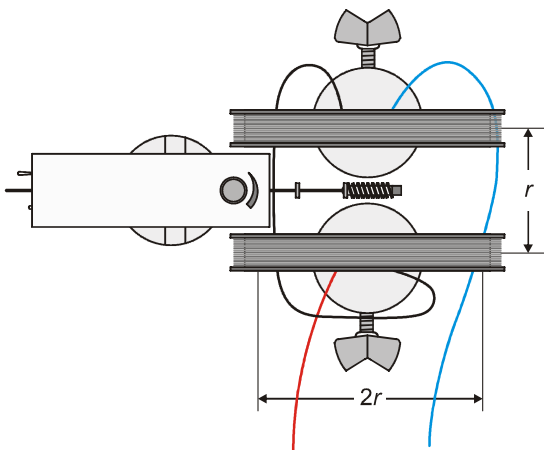

Fig. 5 Arrangement of the Helmholtz coils viewed from above.

Setup

The experimental setup is illustrated in Figs. 4 and 5.

- Set up the Helmholtz coils mechanically parallel to each other at an average distance of 6.8 cm (equal to the average radius r).
- Connect the Helmholtz coils electrically in series to each other and to the ESR control unit, note the details in Fig. 5.
- Connect the ESR basic unit to the ESR control unit via the 6-pole cable.
- Connect the output "ESR Signal" of the ESR control unit to channel II (y-Axis) of the two-channel oscilloscope and the output "B-Signal" to channel I (x-Axis) via BNC cables.

Carrying out the experiment

Determining the resonance magnetic field B_0 :

- Put on the plug-in coil 15-30 MHz (the biggest one of the three coils) and insert the DPPH sample so that it is in the centre.
- Switch the ESR basic unit on and set it up so that the plug-in coil with the DPPH sample is located in the centre of the pair of Helmholtz coils (see Fig. 5).
- Set the resonance frequency $\nu = 15$ MHz (potentiometer on top of the basic unit).

- Set the modulation amplitude I_{\sim} to the middle.
- Set the phase shift to the right (potentiometer Phase).
- Select two-channel operation at the oscilloscope.

Dual	on	
time base	2	ms/cm
Amplitude I and II	0.5 V/cm AC	

- Use the button on the control unit to switch the display of the control unit to "A=", showing the value of I_{\sim} . Slowly enhance the equidirectional field of the Helmholtz coils with the current I_{\sim} until the resonance signals are equally spaced (see Fig. 3). At a frequency of 15 MHz this will be at an approximate current of 0.13 A.
- Switch the oscilloscope to XY operation, and set the phase shift so that the two resonance signals coincide (see Fig. 2).
- Vary the direct current I_{\sim} until the resonance signal is symmetric. Select a modulation current I_{\sim} as small as possible.
- Read the direct current I_{\sim} through the pair of Helmholtz coils, and take it down together with the resonance frequency ν , creating Table 1.

- Increase the resonance frequency ν by 5 MHz, and adjust the new resonance condition by increasing the direct current I_{\sim} .
- Again measure the current I_{\sim} and take it down.
- Continue increasing the high frequency in steps of 5 MHz (use the plug-in coil 30-75 MHz for frequencies greater than 30 MHz and the plug-in coil 75-130 MHz (the smallest one) for frequencies greater than 75 MHz) and repeat the measurements.

Determining the half-width δB_0 :

- Select XY operation at the oscilloscope.
- | | |
|--------------|-------------|
| Amplitude II | 0.5 V/cm AC |
|--------------|-------------|
- Adjust the resonance condition for $\nu = 50$ MHz (medium plug-in coil) once more.
 - Extend the resonance signal in the X direction exactly over the total width of the screen (10 cm) by varying the modulation current I_{\sim} .
 - Switch the control unit display to I_{\sim} and read the RMS (!) value of the modulation current I_{mod} , for example 0.282 A.
 - Spread the X deflection (changing to 0.2 V/cm), read the width ΔU of the resonance signal at half the height of the

oscilloscope screen, and take it down, for example 1.5 cm.

Measuring example

Determining the resonance magnetic field B_0

In Table 1, the current through the series-connected Helmholtz coils I_0 in the case of resonance is listed as a function of the frequency ν of the alternating high frequency field.

Table 1: the current I_0 as a function of the frequency ν of the alternating field

$\frac{\nu}{\text{MHz}}$	$\frac{I}{\text{A}}$	Plug-in coil
15	0.13	big
20	0.17	big
25	0.21	big
30	0.26	big
30	0.26	medium
35	0.30	medium
40	0.34	medium
45	0.38	medium
50	0.43	medium
55	0.47	medium
60	0.51	medium
65	0.55	medium
70	0.60	medium
75	0.64	medium
75	0.64	small
80	0.68	small
85	0.72	small
90	0.77	small
95	0.81	small
100	0.85	small
105	0.89	small
110	0.94	small
115	0.98	small
120	1.02	small
125	1.06	small
130	1.11	small

Determining the half-width δB_0 :

half-width read from the oscilloscope, 1.5 cm corresponding

$$\text{to: } \delta U = 1.5 \text{ cm} \cdot 0.2 \frac{\text{V}}{\text{cm}} = 0.3 \text{ V}$$

Calibration of the full modulation voltage U_{mod} :

$$U_{\text{mod}} = 10 \text{ cm} \cdot 0.5 \frac{\text{V}}{\text{cm}} = 5 \text{ V}$$

corresponds to $I_{\text{mod}} = 0.28 \text{ A}$ (RMS of AC).

Peak-to-peak Amplitude is $2\sqrt{2}$ of RMS.

Evaluation

The magnetic field B of the Helmholtz coils can be calculated from the current I through each coil:

$$B = \mu_0 \cdot \left(\frac{4}{5}\right)^{\frac{3}{2}} \cdot \frac{n}{r} \cdot I \quad \text{with } \mu_0 = 4\pi \cdot 10^{-7} \frac{\text{Vs}}{\text{Am}}$$

(n : number of turns per coil, r : radius of the coils)

With $n = 320$ and $r = 6.8 \text{ cm}$ $B = 4.23 \text{ mT} \cdot \frac{I}{\text{A}}$ is obtained.

Determining the resonance magnetic field B_0 :

In Table 2 the values calculated for the magnetic field are compiled.

Table 2: The magnetic field B_0 as a function of the frequency ν of the alternating field.

$\frac{\nu}{\text{MHz}}$	$\frac{B_0}{\text{mT}}$
15	0.55
20	0.74
25	0.93
30	1.08
35	1.27
40	1.46
45	1.63
50	1.82
55	1.99
60	2.12
65	2.33
70	2.54
75	2.75
80	2.86
85	3.07
90	3,28
95	3.38
100	3.60
105	3.81
110	4.02
115	4.12
120	4.23
125	4.44
130	4.65

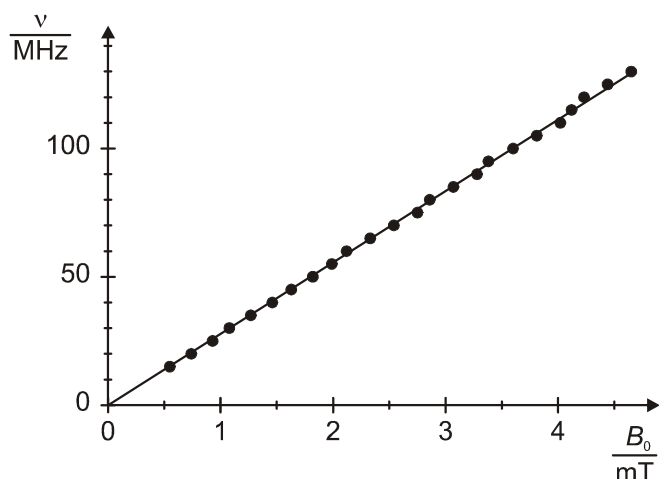

Fig. 6 the resonance frequency as a function of the magnetic field for DPPH

Fig. 6 shows a plot of the measured values. The slope of the straight line through the origin drawn in the plot is

$$\frac{\nu}{B_0} = 27.8 \frac{\text{MHz}}{\text{mT}}.$$

From this the g -factor follows:

$$g = \frac{h \cdot \nu}{\mu_B \cdot B_0} = \frac{6.625 \cdot 10^{-34} \text{Ws}^2}{9.273 \cdot 10^{-24} \text{Am}^2} \cdot 27.8 \frac{\text{MHz}}{\text{mT}} = 1.99$$

Value quoted in the literature: $g(\text{DPPH}) = 2.0036$.

Determining the half-width δB_0 :

$$\delta I = \frac{\delta U}{U_{\text{mod}}} \cdot I_{\text{mod}} = \frac{0.3 \text{ V}}{5 \text{ V}} \cdot 0.28 \text{ A} \cdot 2 \cdot \sqrt{2} = 0.049 \text{ A}$$

From this

$$\delta B_0 = 4.23 \text{ mT} \cdot \frac{\delta I}{\text{A}} = 0.21 \text{ mT}$$

is obtained.

Value quoted in the literature:

$$\delta B_0 (\text{DPPH}) = 0.15\text{-}0.81 \text{ mT}$$

The line width strongly depends on the solvent in which the substance has recrystallized. The smallest value quoted in the literature is obtained with CS_2 as solvent.