



Extensive selection

---

Variety of material and configurations

---

Options to accommodate any application

---

VWR® Clamps & Supports

## TABLE OF CONTENTS

---

Overview	3
Heavy-Duty Clamps	4
Multi-Purpose Clamps	5-9
Specialty Clamps	10-12
Clamp Accessories	13
Connectors & Holders	14-16
Lab-Frames	17-20
Support Stands	21-22
Support Plates	23
Cylinder Bench Clamps	24
Cylinder Wall Brackets	25
Cylinder Stands	26
Flow Control	27
Lab-Jacks	28-29
Miscellaneous	30
Mini Hotplates / Stirrers	31
Stainless Steel Clamps	32

The unique design of these clamps, rods and supports, connectors, and accessories, conceivably offers one of the most extensive selections in the industry. With a variety of sizes, materials, hardware, and designs, there is always an option to accommodate any application.

The following are many options to consider when choosing the right clamp to suit your needs:

**Material:**

A majority of the VWR clamps are made of nickel-plated zinc which possesses a high tensile strength paired with an economical price. The VWR® Stainless Steel Clamp Line is an option that offers higher chemical resistance and durability. Aluminum is another material that is used in some of the products to offer a greater strength with a lighter weight.

**Configuration:**

Multi-purpose extension clamps allow placement of apparatus at various distances from a lab-frame. They are constructed with round extension arms, which allow the clamps to be rotated 360°. Attachment to lab-frames and other apparatus is easily accomplished with a variety of holders that are purchased separately. (See Connectors & Holders section of this brochure pages 14-16.) Other clamps such as the swivel, fixed position, and some of the specialty clamps, have a built-in holder for attaching to lab-frames or other apparatus at a closer distance to the support.

**Prong Type:**

Two-prong clamps are ideal for holding straight-sided apparatus such as burets, thermometers, beakers, and flask necks. Three-prong clamps are more versatile and have the added capability of holding irregularly shaped objects. Clamps are supplied with both non-slip vinyl sleeves and fiberglass covers, for temperatures above 100°C.

**Prong Adjustment:**

Single adjust clamps are great for applications where limited jaw adjustment is required. One prong or “finger” is adjusted using a wing nut, while the other prong remains stationary. Dual adjust clamps offer greater flexibility because both prongs are adjustable over a wider range. Thumbscrews are utilized for easier prong adjustment.

**Connectors and Holders:**

A variety of connectors and holders are available to secure apparatus specific to the different angles, diameters, and weights in your application allowing you to customize as needed.

**Lab-Frames:**

VWR offers a complete choice of standard and custom frames and rods. Corrosion resistant frames and rods are available in aluminum, fiberglass, and stainless steel. Individual rods are available in standard lengths from 41 to 2438mm (1.61 to 96”). Standard lab-frame sets are available in five sizes. Combined with VWR accessories, these frames and rods can be adjusted to fit any need. Custom lab-frame designs are available to meet your exacting requirements.

Depend on VWR for your custom mounting and sizing needs. Simply contact VWR for personal design and fabrication assistance.

# VWR® Talon® Heavy-Duty Clamps

## VWR® Heavy-Duty Clamps

- Large grip adjustment range
- Single or dual adjust
- Available in three sizes; small, medium, and large
- Nickel-plated zinc

VWR patented multi-purpose Talon® Heavy-Duty Clamps feature an innovative closed yoke construction that minimizes contamination and corrosion of internal components. The unique design enables secure gripping and positioning with added strength and durability.

Available in both single and dual prong adjustment, prongs open gradually to maximize grip size without binding. Both designs feature precise pressure regulation when gripping glassware surfaces to reduce the chance of breakage. Talon® clamps are constructed with extension rods for easy attachment to lab-frames and other apparatus. Supplied with non-slip vinyl sleeves, and for temperatures above 100°C, fiberglass covers.

The prong height of the Talon® Heavy-Duty Clamps makes them ideal for use in holding and securing glassware with precision ground glass joints. The chart details which Talon® Clamps are recommended.

**NOTE:** An additional holder must be purchased in order to attach clamps to frames or other apparatus.

See the Connectors & Holders section of this brochure, pages 14-16.

Replacement vinyl and fiberglass sleeves are available, page 13.

GROUND GLASS JOINT REFERENCE CHART	
Clamp	Joint Size (mm)
Small Dual Adjust	10/30, 12/30, 14/20, 19/22, 24/40, 29/42, 34/45
Medium Dual Adjust	14/40, 19/38
Large Dual Adjust	45/50

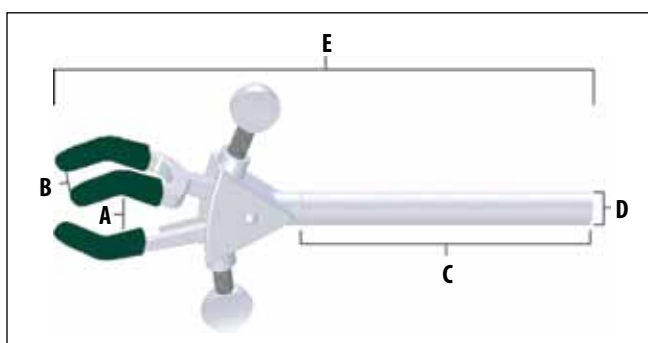

## Single Adjust Clamps



## Dual Adjust Clamps



### 3-Prong Single Adjust Clamps

Size	(A) Min. to Max. Grip Size	(B) Prong Width	(C) Arm Length	(D) Arm Dia.	(E) Overall Length	VWR Cat. No.
Small	0 to 23mm (0 to 0.91")	6mm (0.24")	102mm (4")	8mm (0.31")	162mm (6.38")	<b>21572-805</b>
Medium	0 to 50mm (0 to 1.97")	19mm (0.75")	127mm (5")	11mm (0.43")	229mm (9.02")	<b>21572-803</b>
Large	0 to 72mm (0 to 2.83")	29mm (1.14")	127mm (5")	11mm (0.43")	260mm (10.24")	<b>21572-801</b>

### 3-Prong Dual Adjust Clamps

Size	(A) Min. to Max. Grip Size	(B) Prong Width	(C) Arm Length	(D) Arm Dia.	(E) Overall Length	VWR Cat. No.
Small	0 to 32mm (0 to 1.26")	6mm (0.24")	102mm (4")	8mm (0.31")	152mm (5.98")	<b>21572-804</b>
Medium	0 to 70mm (0 to 2.76")	19mm (0.75")	127mm (5")	11mm (0.43")	222mm (8.74")	<b>21572-802</b>
Large	0 to 103mm (0 to 4.06")	29mm (1.14")	127mm (5")	11mm (0.43")	260mm (10.24")	<b>21572-800</b>

## VWR® Stainless Steel Multi-Purpose Clamps

- **Stainless steel, electro-polished finish**
- **Large dual adjustment range**
- **Available in three sizes; small, medium, and large**

These durable, multi-purpose clamps are made entirely of stainless steel with an electro-polished finish and offer excellent chemical resistance and overall strength. The versatile 3-prong design secures various lab apparatus such as jointed glassware, columns, flasks, and tubes. Dual prong adjustments offer a wide range of motion. Long stainless steel extension arm offers easy positioning and depth adjustment. Autoclavable. Supplied with non-slip vinyl sleeves, and for temperatures above 100°C, fiberglass covers.

**NOTE:** An additional holder must be purchased in order to attach clamps to frames or other apparatus.

See the Connectors & Holders section of this brochure, pages 14-16.

Replacement vinyl and fiberglass sleeves are available, page 13.

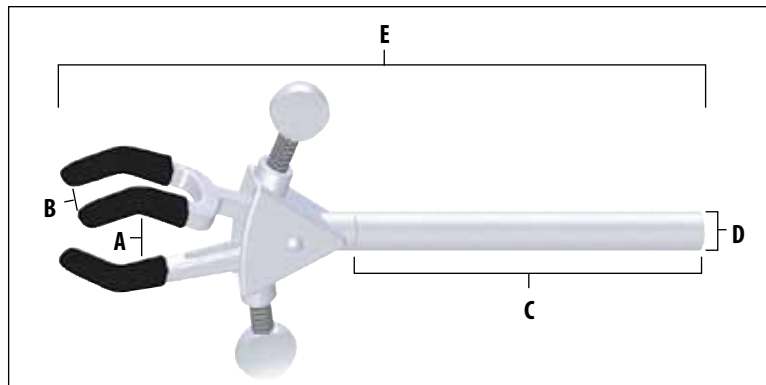

3-Prong Stainless Steel Dual Adjust Clamps						
Size	(A) Min. to Max. Grip Size	(B) Prong Width	(C) Arm Length	(D) Arm Dia.	(E) Overall Length	VWR Cat. No.
Small	0 to 48mm (0 to 1.89")	13mm (0.51")	102mm (4")	10mm (0.39")	172mm (6.77")	12621-240
Medium	0 to 69mm (0 to 2.72")	19mm (0.75")	127mm (5")	13mm (0.51")	229mm (9.02")	12621-238
Large	0 to 102mm (0 to 2.72")	19mm (0.75")	127mm (5")	13mm (0.51")	229mm (9.02")	12621-236

## VWR® Heavy-Duty Tapered Clamps

Heavy-Duty 4-prong, dual adjust tapered clamps are designed to hold large vessels with ground glass joint necks. Clamps are constructed with extension rods for easy attachment to lab-frames and other apparatus. Nickel-plated zinc construction.

**NOTE:** An additional holder must be purchased in order to attach clamps to frames or other apparatus.

See the Connectors & Holders section of this brochure, pages 14-16.

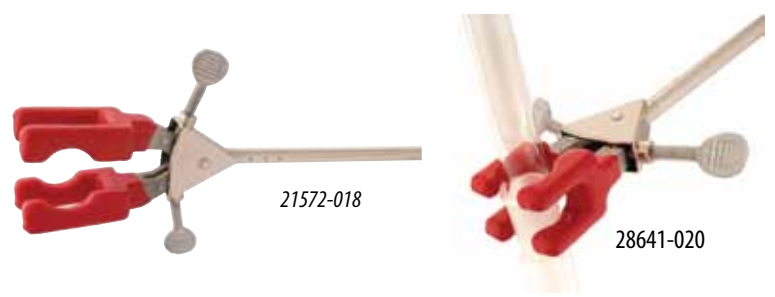

Heavy-Duty Tapered Clamps						
Size	Joint Size	Prong Width	Arm Length	Arm Dia.	Overall Length	VWR Cat. No.
Small	24/40mm	16mm (0.63")	229mm (9.02")	13mm (0.51")	356mm (14")	28641-018
Large	34/45mm	19mm (0.75")	229mm (9.02")	13mm (0.51")	381mm (15")	28641-020

# VWR® Talon® Multi-Purpose Clamps

## VWR® 3-Prong Multi-Purpose Clamps

- Large grip adjustment range
- 3-prong construction
- Single or dual adjust
- Nickel-plated zinc

Designed to securely hold every type of laboratory glassware and apparatus. Long, seamless nickel-plated brass tubing attaches clamp head securely and offers easy positioning in the deepest fume hoods. Clamps are constructed with round extension arms, which allow the clamps to be rotated 360°. Extension arms also allow placement of apparatus at various distances from lab-frames without compromising the integrity of your experiment. Supplied with non-slip vinyl sleeves, and for temperatures above 100°C, fiberglass covers.

**NOTE:** An additional holder must be purchased in order to attach clamps to frames or other apparatus.

See the Connectors & Holders section of this brochure, pages 14-16.

Replacement vinyl and fiberglass sleeves are available, page 13.

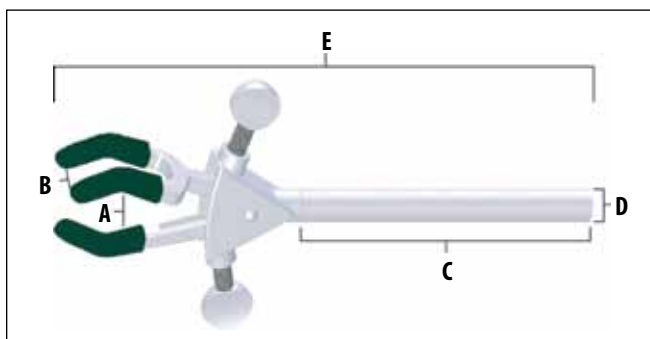

## 3-Prong Single Adjust Clamps



## 3-Prong Dual Adjust Clamps



### 3-Prong Single Adjust Clamps

Size	(A) Min. to Max. Grip Size	(B) Prong Width	(C) Arm Length	(D) Arm Dia.	(E) Overall Length	VWR Cat. No.
Small	0 to 39mm (0 to 1.54")	11mm (0.43")	102mm (4")	8mm (0.31")	160mm (6.3")	<b>21570-125</b>
Medium	0 to 71mm (0 to 2.8")	19mm (0.75")	127mm (5")	11mm (0.43")	218mm (8.58")	<b>21570-126</b>
Large	0 to 108mm (0 to 4.25")	29mm (1.14")	127mm (5")	11mm (0.43")	248mm (9.76")	<b>21570-127</b>

### 3-Prong Dual Adjust Clamps

Size	(A) Min. to Max. Grip Size	(B) Prong Width	(C) Arm Length	(D) Arm Dia.	(E) Overall Length	VWR Cat. No.
Small	0 to 46mm (0 to 1.81")	11mm (0.43")	102mm (4")	8mm (0.31")	168mm (6.61")	<b>21570-200</b>
Medium	0 to 69mm (0 to 2.72")	19mm (0.75")	127mm (5")	11mm (0.43")	229mm (9.02")	<b>21570-302</b>
Medium (extended)	0 to 69mm (0 to 2.72")	19mm (0.75")	305mm (12")	11mm (0.43")	406mm (15.98")	<b>97035-502</b>
Large	0 to 105mm (0 to 4.13")	29mm (1.14")	127mm (5")	11mm (0.43")	273mm (10.75")	<b>21570-404</b>
Large	0 to 105mm (0 to 4.13")	29mm (1.14")	305mm (12")	11mm (0.43")	451mm (17.76")	<b>97035-504</b>

## VWR® 2-Prong Multi-Purpose Clamps

- Large grip adjustment range
- 2-prong construction
- Single or dual adjust
- Nickel-plated zinc

Designed to securely hold laboratory glassware and apparatus. Long, seamless nickel-plated brass tubing attaches clamp head securely and offers easy positioning in the deepest fume hoods. Clamps are constructed with round extension arms, which allow the clamps to be rotated 360°. Extension arms also allow placement of apparatus at various distances from lab-frames without compromising the integrity of your experiment. Supplied with non-slip vinyl sleeves, and for temperatures above 100°C, fiberglass covers.

**NOTE:** An additional holder must be purchased in order to attach clamps to frames or other apparatus.

See the Connectors & Holders section of this brochure, pages 14-16.

Replacement vinyl and fiberglass sleeves are available, page 13.

### 2-Prong Single Adjust Clamps



21570-007



21570-109

### 2-Prong Dual Adjust Clamps

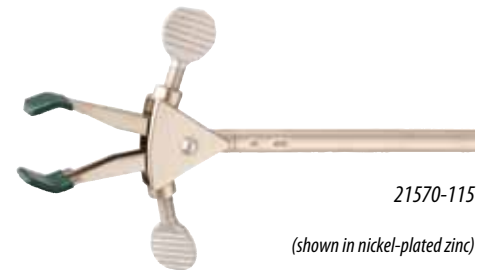

21570-115

(shown in nickel-plated zinc)

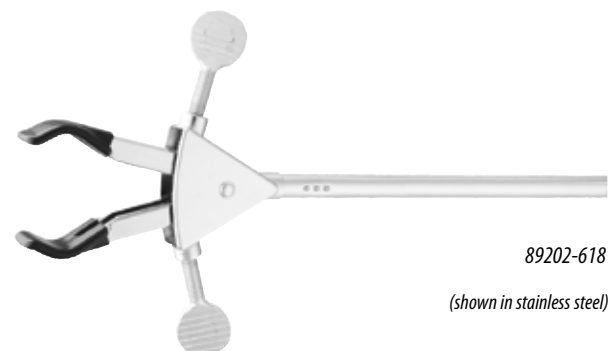
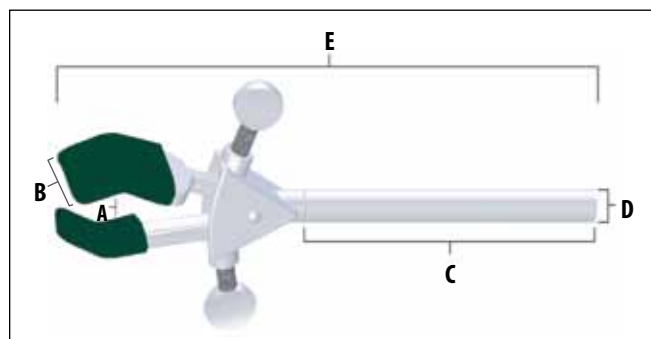

89202-618

(shown in stainless steel)

### 2-Prong Single Adjust Clamps

Material	Size	(A) Min. to Max. Grip Size	(B) Prong Width	(C) Arm Length	(D) Arm Dia.	(E) Overall Length	VWR Cat. No.
Nickel-plated zinc	Medium	0 to 78mm (0 to 3.07")	23mm (0.91")	127mm (5")	11mm (0.43")	216mm (8.5")	<b>21570-007</b>
Nickel-plated zinc	Large	0 to 92mm (0 to 3.62")	23mm (0.91")	127mm (5")	11mm (0.43")	229mm (9.02")	<b>21570-109</b>

### 2-Prong Dual Adjust Clamps

Material	Size	(A) Min. to Max. Grip Size	(B) Prong Width	(C) Arm Length	(D) Arm Dia.	(E) Overall Length	VWR Cat. No.
Stainless steel	Medium	0 to 75mm (0 to 2.95")	23mm (0.91")	127mm (5")	11mm (0.43")	229mm (9.02")	<b>89202-612</b>
Nickle-plated zinc	Medium	0 to 75mm (0 to 2.95")	23mm (0.91")	127mm (5")	11mm (0.43")	229mm (9.02")	<b>21570-115</b>
Stainless steel	Large	0 to 95mm (0 to 3.74")	23mm (0.91")	127mm (5")	11mm (0.43")	248mm (9.76")	<b>89202-618</b>
Nickle-plated zinc	Large	0 to 95mm (0 to 3.74")	23mm (0.91")	127mm (5")	11mm (0.43")	248mm (9.76")	<b>21570-120</b>



# VWR® Talon® Multi-Purpose Clamps

## VWR® Swivel Clamps

Used to hold apparatus near the lab-frame. Unlike extension clamps, the swivel clamps have an integral holder for attaching to a lab-frame or other apparatus. Built-in holder grips rods up to 19mm (0.75") in diameter and is adjustable for forward or reverse-facing adjustment screws. Shaft wing nut allows the holding angle of the swivel clamp to adjust through 360° of rotation and can be locked in place once desired position is achieved. Nickel-plated zinc construction. Supplied with non-slip vinyl sleeves, and for temperatures above 100°C, fiberglass covers.

**NOTE:** Replacement vinyl and fiberglass sleeves are available, page 13.



89202-622  
(shown in stainless steel)

21573-504  
(shown in nickel-plated zinc)

Material	Description	Size	Min. to Max. Grip Size	Prong Width	Overall Length	VWR Cat. No.
Stainless steel	2-Prong Single Adjust	Medium	0 to 76mm (0 to 3")	23mm (0.91")	163mm (6.42")	<b>89202-624</b>
Nickel-plated zinc	2-Prong Single Adjust	Medium	0 to 76mm (0 to 3")	23mm (0.91")	163mm (6.42")	<b>21573-504</b>
Nickel-plated zinc	2-Prong Single Adjust	Large	0 to 95mm (0 to 3.74")	23mm (0.91")	180mm (7.09")	<b>21573-606</b>
Stainless steel	3-Prong Dual Adjust	Medium	0 to 69mm (0 to 2.72")	20mm (0.79")	178mm (7.01")	<b>89202-622</b>
Nickel-plated zinc	3-Prong Dual Adjust	Medium	0 to 69mm (0 to 2.72")	20mm (0.79")	178mm (7.01")	<b>21573-708</b>

## VWR® Fixed-Position Clamps

Used to hold apparatus near the lab-frame where no adjustment is required after set-up. Built-in holder grips rods up to 19mm (0.75") in diameter. Fixed-position clamps have an integral holder but can be rotated after attachment to a lab-frame or other apparatus. Available in 2-prong or 3-prong. Nickel-plated zinc construction. Supplied with non-slip vinyl sleeves, and for temperatures above 100°C, fiberglass covers.

**NOTE:** Replacement vinyl and fiberglass sleeves are available, page 13.

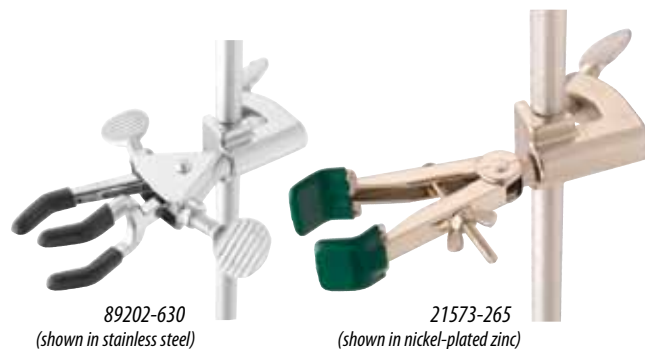

89202-630  
(shown in stainless steel)

21573-265  
(shown in nickel-plated zinc)

Material	Description	Size	Min. to Max. Grip Size	Prong Width	Overall Length	VWR Cat. No.
Stainless steel	2-Prong Single Adjust	Medium	0 to 77mm (0 to 3.03")	23mm (0.91")	133mm (5.24")	<b>89202-632</b>
Nickel-plated zinc	2-Prong Single Adjust	Medium	0 to 77mm (0 to 3.03")	23mm (0.91")	133mm (5.24")	<b>21573-266</b>
Stainless steel	3-Prong Dual Adjust	Medium	0 to 69mm (0 to 2.72")	20mm (0.79")	146mm (5.75")	<b>89202-630</b>
Nickel-plated zinc	3-Prong Dual Adjust	Medium	0 to 69mm (0 to 2.72")	20mm (0.79")	146mm (5.75")	<b>21573-265</b>

## VWR® Double Jaw Utility Clamp

Swivels 360° and locks securely in desired position. These 2-prong clamps have a medium and a large clamp on opposite ends. Nickel-plated zinc construction. Supplied with non-slip vinyl sleeves, and for temperatures above 100°C, fiberglass covers.

**NOTE:** Replacement vinyl and fiberglass sleeves are available, page 13.



Description	Min. to Max. Grip Size	Prong Width	Overall Length	VWR Cat. No.
Medium 2-prong	0 to 76mm (0 to 2.99")	23mm (0.91")	222mm (8.74")	<b>21573-800</b>
Large 2-prong	0 to 95mm (0 to 3.74")	23mm (0.91")	222mm (8.74")	<b>21573-800</b>



## VWR® Thermometer Swivel Clamp

Holds glass tubes and thermometers 114mm (4.49") from support rod. Clamp features safety adjust spring plate jaws that adjust to any angle with locking wing nut. Built-in holder grips rods up to 19mm (0.75") in diameter. Lightweight, rust, and corrosion-resistant. Nickel-plated construction.

Min. to Max. Grip Size	Overall Length	VWR Cat. No.
6 to 8mm (0.24 to 0.31")	159mm (6.26")	21573-060



21573-060

## VWR® Thermometer / Thermocouple Extension Clamp

Lightweight clamp holds glass tubing/thermometers or thermocouples up to 178mm (7") from support rod. Tightening wing nut applies tension to the nickel-plated jaws.

**NOTE:** An additional holder must be purchased in order to attach clamps to frames or other apparatus. See the Connectors & Holders section of this brochure, pages 14-16.

Min. to Max. Grip Size	Ext Arm Length	Arm Dia.	Overall Length	VWR Cat. No.
6 to 12mm (0.24 to 0.47")	127mm (5")	11mm (0.43")	210mm (8.27")	21573-071

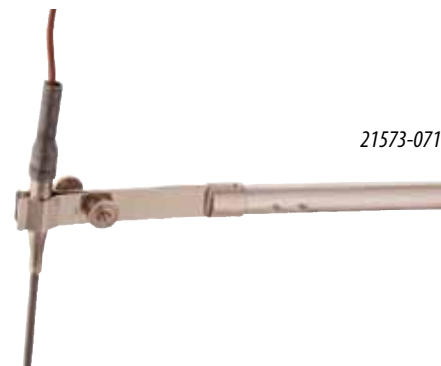

21573-071

## VWR® Wall Clamp

Ideal for securing fermentation tubes, burets, or other small objects to walls where no frames are available. Integral self-tapping screw secures clamp to wall. Nickel-plated construction.

Min. to Max. Grip Size	Overall Length	VWR Cat. No.
5 to 10mm (0.2 to 0.39")	80mm (3.15")	21573-154



21573-154

## VWR® Water Bath Clamps

Holds a variety of apparatus, including glass tubes and thermometers onto glass water bath walls. Built-in holder grips walls of varying thickness, up to 9mm (0.35"). Knurled thumbscrew tightens jaws to hold objects firmly. Nickel-plated zinc construction. Large water bath clamp is supplied with non-slip vinyl sleeves, and for temperatures above 100°C, fiberglass covers.

**NOTE:** Replacement vinyl and fiberglass sleeves are available, page 13.

Size	Min. to Max. Grip Size	Prong Width	Overall Length	VWR Cat. No.
Small	5 to 10mm (0.2 to 0.39")	N/A	89mm (3.5")	21573-129
Large	0 to 46mm (0 to 1.81")	11mm (0.43")	117mm (4.61")	21573-151



21573-129



21573-151

# VWR® Talon® Specialty Clamps

For the items listed below an additional holder must be purchased in order to attach clamps to frames or other apparatus. See the Connectors & Holders section of this brochure, pages 14-16.

## VWR® Chain Clamps

Holds large round or irregular shaped objects firmly, yet gently to lab-frames and rods. Quick and secure slip-on chain connection with large, easy-to-turn adjusting knob. Extension arm allows user to vary distance from the frame. Constructed of nickel-plated zinc with strong, chromed-brass chain.

Size	Min. to Max. Dia. Size	Ext. Arm Length	Arm Dia.	Overall Length	VWR Cat. No.
Small	35 to 170mm (1.38 to 6.69")	127mm (5")	13mm (0.51")	188mm (7.4")	<b>21573-275</b>
Large-5	35 to 280mm (1.38 to 11.02")	127mm (5")	13mm (0.51")	206mm (8.11")	<b>21572-729</b>
Large-12	35 to 280mm (1.38 to 11.02")	305mm (12")	13mm (0.51")	384mm (15.12")	<b>97035-506</b>
<b>Stainless Steel</b>					
Large-5	35 to 280mm (1.38 to 11.02")	127mm (5")	13mm (0.51")	206mm (8.11")	<b>89202-620</b>



89202-620  
(shown in stainless steel)

## VWR® Column Clamps

These sturdy, easily adjusted, multi-purpose clamps are ideal for holding large cylindrical glassware and similar objects. A large, flat thumbscrew/worm-drive permits maximum tightening or removal in minimum time. Clamp is constructed of corrosion-resistant stainless steel. Ideal for chromatography columns.

Size	Min. to Max. Dia. Size	Ext. Arm Length	Arm Dia.	Overall Length	VWR Cat. No.
Small	65 to 89mm (2.56 to 3.5")	211mm (8.31")	11mm (0.43")	282mm (11.1")	<b>21572-104</b>
Medium	91 to 114mm (3.58 to 4.49")	211mm (8.31")	11mm (0.43")	315mm (12.4")	<b>21572-137</b>
Large	64 to 140mm (2.52 to 5.51")	211mm (8.31")	11mm (0.43")	338mm (13.31")	<b>21572-160</b>
X-Large	92 to 165mm (3.62 to 6.5")	211mm (8.31")	11mm (0.43")	368mm (14.49")	<b>21572-192</b>



Column Clamps

## VWR® Nester Extension Clamp

Securely holds large or small glass distillation columns and odd-shaped glassware. Constructed of stainless steel with strong, chromed-brass band and chain.

Min. to Max. Dia. Size	Ext. Arm Length	Arm Dia.	Overall Length	VWR Cat. No.
50 to 102mm (1.97 to 4.02")	152mm (5.98")	10mm (0.39")	262mm (10.31")	<b>21572-002</b>



21572-002

## VWR® PVC Coated Open Extension Rings

Ideal for supporting funnels, round bottom flasks, reaction vessels, and other apparatus that requires lower support. Opening in PVC coated aluminum ring allows for easy removal of sample container. PVC coating protects glassware. Long extension arm permits depth adjustment of the open ring from the lab-frame or ring stand.

Ring Dia.	Ext. Arm Length	Arm Dia.	Overall Length	VWR Cat. No.
76mm (3")	254mm (10")	9mm (0.35")	328mm (12.91")	<b>97019-054</b>
102mm (4")	305mm (12")	9mm (0.35")	404mm (15.91")	<b>97019-056</b>
127mm (5")	305mm (12")	11mm (0.43")	427mm (16.81")	<b>97019-058</b>



PVC Coated Open Rings

## VWR® Open Rings

Lightweight rings mount funnels, boiling flasks, and other irregular-shaped objects to lab-frames. Open ring section allows items to pass in and out of support area easily, reducing risk of breakage. Aluminum construction.

Ring Dia.	Ext. Arm Length	Arm Dia.	Overall Length	VWR Cat. No.
76mm (3")	58mm (2.28")	9mm (0.35")	132mm (5.2")	<b>28641-010</b>
102mm (4")	58mm (2.28")	9mm (0.35")	158mm (6.22")	<b>28641-012</b>
127mm (5")	61mm (2.4")	11mm (0.43")	183mm (7.2")	<b>28641-014</b>



Open Rings

## VWR® Buret Holders

Double Buret Clamp holds any size buret from micro to 100mL capacity. Simply compress the scissor-like mechanism, insert buret and gently release to grip. Numbers and graduation on buret remain easy-to-read. For height adjustments, recompress mechanism and slide buret up or down and gently release. Clamp unit attaches to optional standard support rod with built-in reinforced hook connector. Adjusting nut faces forward for easy use. Aluminum support rod attaches to optional porcelain base.

**Support Rod (dia. x L):** 13 x 578mm (0.51 x 22.76")

**Porcelain Base (L x W x H):** 178 x 330 x 25mm (7 x 13 x 1")

Description	VWR Cat. No.
Double Buret Clamp (only)	17683-258
Support Stand with Rod (only)	17683-054
Double Buret Clamp & Support Stand with Rod (complete)	17683-000

Stainless Steel	
Description	VWR Cat. No.
Double Buret Clamp (only)	89202-626
Support Rod (only)	89202-638
Support Stand with Rod (only)	89202-634
Double Buret Clamp & Support Stand with Rod (complete)	89202-636

## VWR® Kettle Clamps

Holds flask and cover together firmly. Three insulated spring-activated clamping arms. Stainless steel springs. For use on reaction kettles.

Flask Size	Inside Dia.	VWR Cat. No.
500mL, 1000mL	125mm (4.92")	36393-030
2000mL, 3000mL, 4000mL	142mm (5.59")	36393-051

## VWR® Electrode Support Clamp

Permits suspension of electrodes over beaker for potentiometric titrations. Holds any electrode clamp at desired level. Built-in nickel-plated zinc holder grips rods up to 19mm (0.75") in diameter.

Overall Length	VWR Cat. No.
178mm (7")	21573-152

## VWR® Suspension Clamp

Holds thermometers, potash bulbs, or drying tubes 114mm (4.49") from support rod. Machine tapered, nickel-plated brass hook won't bend, rust, or corrode. Built-in holder grips rods up to 19mm (0.75") in diameter.

Overall Length	VWR Cat. No.
137mm (5.39")	21573-153

## VWR® Support Clamp

Supports electrolysis apparatus, glass rods, or tubing at any angle. Arms are nickel-plated brass with vinyl coating. Easily supports cylindrical objects up to 19mm (0.75") in diameter. Built-in holder grips rods up to 19mm (0.75") in diameter.

Overall Length	Prong Width	VWR Cat. No.
152mm (5.99")	25mm (1")	21573-038



89202-636  
(shown in stainless steel)



36393-030



21573-152



21573-153

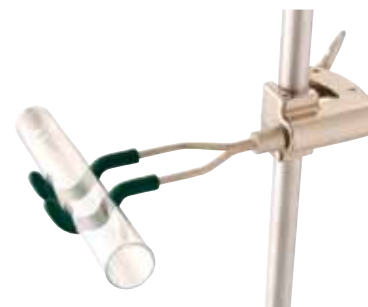

21573-038

# VWR® Talon® Specialty Clamps

VWR® Ultra Flex Support Systems have unique flexible arms that are extremely versatile and can be placed in virtually any position or angle. Ultra Flex comes in three different systems; base plate, lab-frame connector, and bench clamp. Each system includes a 2-Prong Clamp Head, 3-Prong Clamp Head, Spring Clamp Head, nickel-plated flex arm in 305mm (12") or 457mm (18") length, and utility wrench. 2-prong and 3-prong clamp heads also supplied with non-slip vinyl sleeves, and for temperatures above 100°C, fiberglass covers.

<b>Arm Length,</b>	<b>Ultra Flex 12:</b>	305mm (12")
	<b>Ultra Flex 18:</b>	457mm (18")
<b>Arm Diameter:</b>		13mm (0.51")
<b>Max. Grip Size,</b>	<b>2-Prong Clamp Head:</b>	75mm (2.95")
	<b>3-Prong Clamp Head:</b>	69mm (2.72")
	<b>Spring Clamp Head:</b>	13mm (0.51")

2-Prong Clamp Head



3-Prong Clamp Head



Spring Clamp Head



## VWR® Ultra Flex Support System with Base Plate

- **Stable base plate**
- **All metal construction**

VWR® Ultra Flex Support System with Base Plate is designed with a stable, steel base plate with chemical resistant black finish that fits easily on bench tops or in fume hoods.

Description	VWR Cat. No.
Ultra Flex 12 with Base Plate	12621-208
Ultra Flex 18 with Base Plate	12621-210



12621-210

## VWR® Ultra Flex Support System with Lab-Frame Connector

- **Cast alloy lab-frame connector**
- **Mounts to lab-frames or support stands**

VWR® Flex Support System with Lab-Frame Connector securely attaches to support stands, lab-frames, or any support rod up to 19mm (0.75") in diameter. Ideal for use in fume hoods. Lab-frame connector is made of cast alloy.

Description	VWR Cat. No.
Ultra Flex 12 with Lab-Frame Connector	12621-216
Ultra Flex 18 with Lab-Frame Connector	12621-218



12621-216

## VWR® Ultra Flex Support System with Bench Clamp

- **Aluminum bench clamp**
- **Easily attaches to most lab benches**

VWR® Ultra Flex Support System with Bench Clamp easily attaches to the side of your lab bench or counter top, which helps utilize more space in your lab. Bench clamp is aluminum.

Description	VWR Cat. No.
Ultra Flex 12 with Bench Clamp	12621-212
Ultra Flex 18 with Bench Clamp	12621-214



12621-212

## Replacement Parts

Description	VWR Cat. No.
2-Prong Clamp Head	12621-224
3-Prong Clamp Head	12621-226
Spring Clamp Head	12621-228
305mm (12") Flex Arm	12621-220
451mm (18") Flex Arm	12621-222
Base Plate	12621-230
Lab-Frame Connector	12621-234
Bench Clamp	12621-232

## VWR® Replacement Sleeves

Sleeves are easily removed for cleaning or replacement. Both vinyl and fiberglass sleeves are available. Fiberglass sleeves are recommended for all applications above 100°C (212°F).



Clamp Size	Green Vinyl Sleeve VWR Cat. No.	Fiberglass Sleeve VWR Cat. No.
Medium 2-Prong (2 pack)	21572-900	21572-901
Large 2-Prong (2 pack)	21572-902	21572-903
Small 3-Prong (3 pack)	21572-904	21572-905
Medium 3-Prong (3 pack)	21572-906	21572-907
Large 3-Prong (3 pack)	21572-908	

## VWR® Thumbscrew Knob

Thumbscrew tightening knob features a 32mm (1.26") slot in the center of a nylon disc that will accept thumbscrews supplied with the Talon® Multi-Purpose Clamps, excluding the stainless steel version. Makes tightening of clamps easier on the hands and wrists.



Overall Diameter	Thumbscrew Slot	VWR Cat. No.
64mm (2.5")	32mm (1.26")	14217-750



### Need a lab-frame?

See pages 17-20 for a variety of options and materials.

Don't see what you want, call your VWR representative to customize a frame to **your** exact specifications.



# VWR® Talon® Connectors & Holders

## VWR® Regular Holder

Ideal for holding clamps to lab-frames. Use wherever clamping at 90° is required. Nickel-plated zinc construction.

Material	Min. to Max. Grip Size	VWR Cat. No.
Stainless Steel	0 to 18mm (0 to 0.71")	<b>89202-610</b>
Nickel-Plated Zinc	0 to 18mm (0 to 0.71")	<b>21572-501</b>



## VWR® Jumbo Holder

Stainless steel electro-polished finish or aluminum construction. Ideal for holding clamps to lab-frames or ring stands.

Material	Min. to Max. Grip Size	VWR Cat. No.
Stainless Steel	0 to 21mm (0 to 0.83")	<b>12621-250</b>
Aluminum	0 to 21mm (0 to 0.83")	<b>21572-556</b>



## VWR® Heavy-Duty Holder

For mounting stirrers and other apparatus. Clamp is constructed of strong aluminum alloy; fitted with over-sized knobs for very secure positioning. Rods supported on 102mm (4") long surface to avoid vibration and wobble.

Material	Min. to Max. Grip Size	VWR Cat. No.
Aluminum	6 to 24mm (0.24 to 0.94")	<b>14216-208</b>



## VWR® Swivel Holder

Two rod holders with center swivel capacity allow tilting of clamps at any angle in parallel planes. Outside adjustment screw allows close proximity between items being held. Nickel-plated zinc construction.

Material	Min. to Max. Grip Size	VWR Cat. No.
Stainless Steel	0 to 19mm (0 to 0.75")	<b>89202-628</b>
Nickel-Plated Zinc	0 to 19mm (0 to 0.75")	<b>21572-603</b>



## VWR® All-Position Clamp Holder

Surpass standard holding capabilities. The all-position clamp holder permits adjustment at any angle in any plane. Holders are set at 90° to each other, connected by a 90° connector, allowing 360° rotation. Nickel-plated zinc construction.

Min. to Max. Grip Size	VWR Cat. No.
0 to 19mm (0 to 0.75")	<b>21572-658</b>



## VWR® Hook Connector

Stainless steel electro-polished finish or nickel-plated zinc construction. Simple, versatile, and easy-to-use. Hook connectors allow one-handed assembly of two components with one adjustment screw.

Material	Min. to Max. Grip Size	VWR Cat. No.
Stainless Steel	0 to 13mm (0 to 0.51")	<b>12985-062</b>
Nickel-Plated Zinc	0 to 13mm (0 to 0.51")	<b>60079-166</b>



## VWR® End-to-End Connector

Extend the length of lab-frame rods. Strong aluminum alloy connector permits end-to-end joining of rods. Precision boring of connector ensures perfect alignment of rods. Corrosion-resistant. Comes with two set screws.

Min. to Max. Grip Size	VWR Cat. No.
0 to 13mm (0 to 0.51")	<b>60079-100</b>



## VWR® Rod End Connector

Holds rods firmly at 90°. Use when semi-permanent installations are required. Comes with two set screws and is precision bored for close fit. Nickel-plated zinc construction.

Material	Min. to Max. Rod Size	VWR Cat. No.
Stainless Steel	0 to 13mm (0 to 0.51")	<b>89202-616</b>
Nickel-Plated Zinc	0 to 13mm (0 to 0.51")	<b>60079-010</b>



## VWR® S-Connector

Stainless steel electro-polished finish or nickel-plated zinc. Clamp is ideal for constructing lab-frames or other supports requiring the connection of two perpendicular rods. Clamp connects two 13mm (0.51") rods at a 90° angle and features separate adjustment screws for each rod location.

Material	Min. to Max. Grip Size	VWR Cat. No.
Stainless Steel	0 to 13mm (0 to 0.51")	<b>12621-246</b>
Nickel-Plated Zinc	0 to 13mm (0 to 0.51")	<b>60097-056</b>

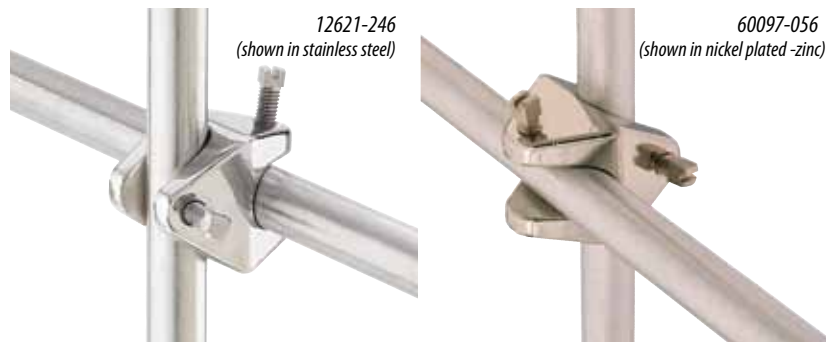

## VWR® Frame Connector (pack of 12)

Improved contour delivers simplicity and strength. Angled adjustment screws allow easy set-up and prevent misalignment. Smooth, rounded surfaces are easy-to-clean. Small size maximizes lab-frame space. Bright dipped aluminum finish sealed with silicon for maximum protection against corrosion.

Min. to Max. Grip Size	VWR Cat. No.
0 to 13mm (0 to 0.51")	<b>60097-055</b>





## VWR® Universal Stirrer Mounting Bracket

Use to mount stirrers and other devices to lab-frames. Aluminum mounting bracket with attachment screws.

Max. Weight Mounted	Min. to Max. Grip	VWR Cat. No.
2.27kg (5lbs)	0 to 20mm (0 to 0.78")	60079-103



60079-103

## VWR® Multi-Rod Connector

Maximum adjustment capability within one connector. Two adjustment rods fit into the oval hole in the connector, preventing turning when tightened. Side and front 13mm (0.51") holes allow creation of a variety of configurations. Nickel-plated zinc construction.

Min. to Max. Rod Size	VWR Cat. No.
0 to 13mm (0 to 0.51")	60079-053



60079-053

## VWR® Wrench

Special adjusting wrench is for use with lab-frame items with set screws.

Length	VWR Cat. No.
79mm (3.11")	60079-108



60079-108

## VWR® Channel Connector

Special connector fastens lab-frame rod to steel 41mm (1.61") channels. Loosen the connector and slide up or down for easy adjustment of rod position.

Dimensions	VWR Cat. No.
33 x 40mm (1.3 x 1.58")	60079-012

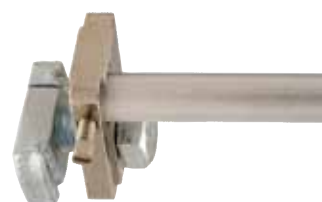

60079-012

## VWR® Horizontal Mounting Bars with Coupler

Threaded end for direct installation into channels. Comes with spring coupler for use in steel 41mm (1.61") channels. Locking nut included. Use with steel channel frames.

Bar Length	VWR Cat. No.
51mm (2")	60079-104
102mm (4")	60079-105
152mm (6")	60079-106
203mm (8")	60079-107



60079-107

## VWR® Frame Rods

Everything you need to customize a lab-frame to your laboratory space. Quality construction throughout. Frame rods are available in many lengths and materials.

### Aluminum

Center-less ground for precise fit. These hard aluminum rods provide a smooth fit with lab-frames. Corrosion resistant with chamfered ends for easy location.

### Fiberglass

Strong and resilient, fiberglass rods will not corrode or rust. Structurally strong and resilient to clamp compression scars.

### Stainless Steel

Heavy-duty, top-of-the-line rods provide maximum strength and durability. Constructed of 303 stainless steel.

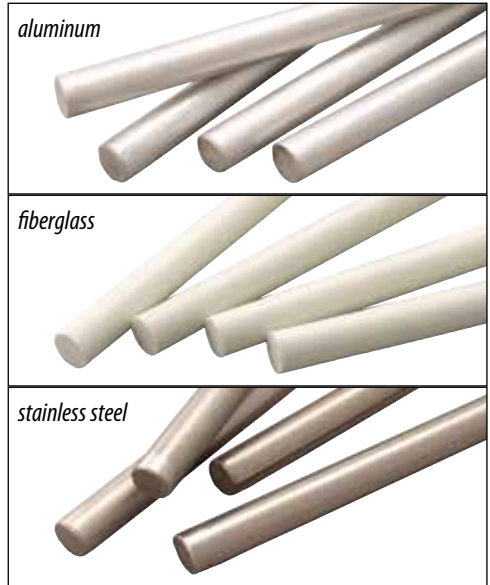

<b>Rod Diameter</b>	<b>Rod Length</b>	<b>Aluminum VWR Cat. No.</b>	<b>Fiberglass VWR Cat. No.</b>	<b>Stainless Steel VWR Cat. No.</b>
13mm (0.51")	41mm (1.61")	<b>60079-325</b>	<b>60079-518</b>	<b>60079-530</b>
13mm (0.51")	51mm (2.0")	<b>60079-326</b>	<b>60079-519</b>	<b>60079-531</b>
13mm (0.51")	152mm (6.0")	<b>60079-348</b>	<b>60079-520</b>	<b>60079-532</b>
13mm (0.51")	305mm (12")	<b>60079-360</b>	<b>60079-521</b>	<b>60079-533</b>
13mm (0.51")	457mm (18")	<b>60079-381</b>	<b>60079-522</b>	<b>60079-534</b>
13mm (0.51")	610mm (24")	<b>60079-406</b>	<b>60079-523</b>	<b>60079-535</b>
13mm (0.51")	914mm (36")	<b>60079-428</b>	<b>60079-524</b>	<b>60079-536</b>
13mm (0.51")	1219mm (48")	<b>60079-440</b>	<b>60079-526</b>	<b>60079-537</b>
13mm (0.51")	1524mm (60")	<b>60079-461</b>	<b>60079-527</b>	<b>60079-538</b>
13mm (0.51")	1829mm (72")	<b>60079-483</b>	<b>60079-528</b>	<b>60079-539</b>
13mm (0.51")	2438mm (96")	<b>60079-508</b>	<b>60079-525</b>	<b>60079-540</b>

## VWR® Lab-Frame Foot

Stainless steel electro-polished finish or nickel-plated zinc construction. Strong, durable lab-frame foot is designed for mounting lab-frames permanently to bench tops, fume hoods, walls, and floors. Spilled fluids roll right off the smooth body contour, minimizing contamination and easing clean-ups. Features a set screw and includes three 0.75" (19mm) mounting screws.

<b>Material</b>	<b>Min. to Max. Grip Size</b>	<b>Dimensions (Dia. x H)</b>	<b>VWR Cat. No.</b>
Stainless Steel	0 to 13mm (0 to 0.51")	70 x 32mm (2.76 x 1.26")	<b>12621-248</b>
Nickel-Plated Zinc	0 to 13mm (0 to 0.51")	70 x 32mm (2.76 x 1.26")	<b>60079-257</b>



## VWR® Lab-Frame Kits

VWR offers the widest choice of standard frames available, plus the accessories to custom-fit any laboratory with the right frame for the job. Standard Lab-Frame sets are available in six sizes. Options of traditional center-less ground aluminum, non-corroding fiberglass, or tough stainless steel rods are available. Nickel-plated zinc connectors and lab-frame feet are standard with all kits.

## VWR® Small Lab-Frame

Vertical mounting, great for glassware set-ups in small laboratories or where space is limited. Frame measures 610 x 610mm (24 x 24"). Base is 457mm (18") wide for stability. Base may be permanently mounted to bench top with screws (included).

- Components:**
- (8) 51mm (2") rods
  - (2) 457mm (18") rods
  - (8) 610mm (24") rods
  - (18) S-Connectors
  - (4) Rod End Connectors
  - (4) Lab-Frame Feet



Frame Dimensions	Base Dimension	<u>Aluminum</u> VWR Cat. No.	<u>Fiberglass</u> VWR Cat. No.	<u>Stainless Steel</u> VWR Cat. No.
610 x 610mm (24 x 24")	457mm (18") wide	<b>60075-008</b>	<b>60079-542</b>	<b>60079-552</b>

## VWR® Medium Lab-Frame

Horizontal or vertical mounting, convenient for distillation or general set-up. Frame measures 610 x 1219mm (24 x 48"). Base is 457mm (18") wide for stability.

- Components:**
- (8) 51mm (2") rods
  - (2) 457mm (18") rods
  - (7) 610mm (24") rods
  - (4) 1219mm (48") rods
  - (35) S-Connectors
  - (4) Rod End Connectors
  - (4) Lab-Frame Feet



Frame Dimensions	Base Dimension	<u>Aluminum</u> VWR Cat. No.	<u>Fiberglass</u> VWR Cat. No.	<u>Stainless Steel</u> VWR Cat. No.
610 x 1219mm (24 x 48")	457mm (18") wide	<b>60075-009</b>	<b>60079-544</b>	<b>60079-554</b>

### VWR® Large Lab-Frame

This 1219 x 1219mm (48 x 48") frame is ideal for complex glassware set-ups. Base is 457mm (18") wide for stability.

- Components:**
- (10) 51mm (2") rods
  - (3) 457mm (18") rods
  - (2) 914mm (36") rods
  - (10) 1219mm (48") rods
  - (38) S-Connectors
  - (4) Rod End Connectors
  - (6) Lab-Frame Feet



Frame Dimensions	Base Dimension	Aluminum VWR Cat. No.	Fiberglass VWR Cat. No.	Stainless Steel VWR Cat. No.
1219 x 1219mm (48 x 48")	457mm (18") wide	60077-003	60079-546	60079-556

### VWR® Extra-Large Lab-Frame

Versatile, adaptable Extra-Large Lab-Frame measures 1219 x 1829mm (48 x 72") and may be used either horizontally or vertically.

- Components:**
- (6) 51mm (2") rods
  - (6) 305mm (12") rods
  - (2) 610mm (24") rods
  - (7) 1219mm (48") rods
  - (5) 1829mm (72") rods
  - (45) S-Connectors
  - (4) Rod End Connectors
  - (8) Lab-Frame Feet



Frame Dimensions	Aluminum VWR Cat. No.	Fiberglass VWR Cat. No.	Stainless Steel VWR Cat. No.
1219 x 1829mm (48 x 72")	60078-006	60079-548	60079-558

## VWR® Heavy-Duty Lab-Frame

Floor mounted, free-standing unit is specifically designed for heavy-duty work such as pilot plant set-ups. Outside frame is constructed of a strong, but lightweight steel channel. Interior lattice uses a horizontal channel connector; one end accommodates the rod, the other end fits into the channel and locks tightly with a bolt. Loosen the bolt, and the connector slides easily along the channel track for simple lattice adjustment. Entire apparatus is supported on sturdy, counter-weighted cast iron feet, which may be bolted to the floor for added stability required in top-heavy installations.

- Components:**
- (5) 1219mm (48") rods
  - (3) 1829mm (72") rods
  - (15) S-Connectors
  - (16) Channel Connectors
  - (24) Clamping Nuts
  - (2) 551mm (21.7") Cast Iron Feet
  - (1) Frame Kit
  - (1) Wrench



Frame Dimensions	Overall Dimension	<u>Aluminum</u> VWR Cat. No.	<u>Fiberglass</u> VWR Cat. No.	<u>Stainless Steel</u> VWR Cat. No.
1219 x 1829mm (48 x 72")	1219mm x 1829mm (75 x 72")	<b>60078-008</b>	<b>60079-550</b>	<b>60079-560</b>

## VWR® Fume Hood Kits

Choose from four kits specifically designed to fit within laboratory fume hoods. Rods are constructed of stainless steel. Connectors and lab-frame feet are constructed of nickel-plated zinc.

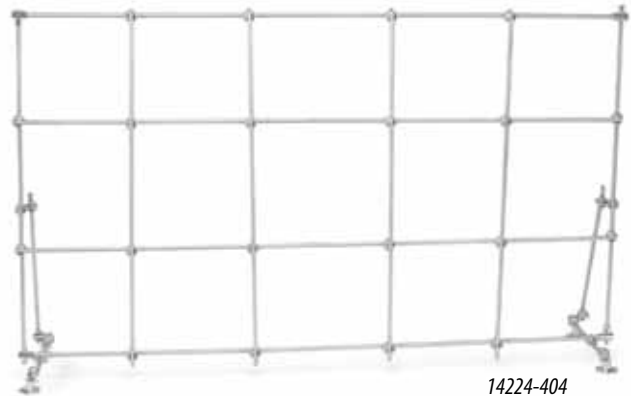

### 1.22m (4') Fume Hood Kit

- Components:**
- (8) 51mm (2") rods
  - (2) 305mm (12") rods
  - (2) 457mm (18") rods
  - (4) 914mm (36") rods
  - (4) 965mm (38") rods
  - (30) Frame Connectors
  - (4) Rod End Connectors
  - (4) Lab-Frame Feet

**Frame:** 914 x 965mm (36 x 38")  
**Base:** 305mm (12") wide

### 1.52m (5') Fume Hood Kit

- Components:**
- (8) 51mm (2") rods
  - (2) 305mm (12") rods
  - (2) 457mm (18") rods
  - (5) 914mm (36") rods
  - (4) 1270mm (50") rods
  - (34) Frame Connectors
  - (4) Rod End Connectors
  - (4) Lab-Frame Feet

**Frame:** 914 x 1270mm (36 x 50")  
**Base:** 305mm (12") wide

### 1.83m (6') Fume Hood Kit

- Components:**
- (8) 51mm (2") rods
  - (2) 305mm (12") rods
  - (2) 457mm (18") rods
  - (6) 914mm (36") rods
  - (4) 62" (1575mm) rods
  - (38) Frame Connectors
  - (4) Rod End Connectors
  - (4) Lab-Frame Feet

**Frame:** 914 x 1575mm (36 x 62")  
**Base:** 305mm (12") wide

### 2.44m (8') Fume Hood Kit

- Components:**
- (10) 51mm (2") rods
  - (3) 305mm (12") rods
  - (2) 457mm (18") rods
  - (8) 914mm (36") rods
  - (4) 2184mm (86") rods
  - (45) Frame Connectors
  - (4) Rod End Connectors
  - (6) Lab-Frame Feet

**Frame:** 914 x 2184mm (36 x 86")  
**Base:** 305mm (12") wide

VWR Cat. No.	VWR Cat. No.	VWR Cat. No.	VWR Cat. No.
14224-400	<b>14224-402</b>	<b>14224-404</b>	<b>14224-406</b>

## VWR® Support Stands

This Support Stand is made entirely of 303 stainless steel. It consists of a sturdy base that can accommodate vessels up to 457mm (18") in diameter within the "U" shaped base. The threaded stainless steel support rod is 16mm (0.63") in diameter and is screwed into the support stand base. The base measures 451mm (17.75") across and 267mm (10.5") deep overall.

**\* Includes support rod.**

Description	VWR Cat. No.
Support Stand with 584.2mm (23") Rod	<b>14010-002</b>
Support Stand with 711.2mm (28") Rod	<b>58958-459</b>
Support Stand with 914.4mm (36") Rod	<b>14010-004</b>
Support Stand with 1016mm (40") Rod	<b>97035-508</b>
Support Stand with 1219.2mm (48") Rod	<b>14010-008</b>
Support Stand with 152.4mm (60") Rod	<b>14010-010</b>

## VWR® Support Stand Stabilizer Knobs

Support Stand Stabilizer Knobs can be added to the two additional threaded holes in the base legs to secure the stand to a bench top.

Description	VWR Cat. No.
Support Stand Stabilizer Knobs (2 per pack)	<b>58958-462</b>

## VWR® Heavy-Duty Support Stands

Heavy-Duty Support Stand was designed to permit cylindrical vessels up to 305mm (12") in diameter to sit close to the support rod. Support rod is ideal for mounting stirring motors for heavy equipment. Each of the four corners rests on a rubber cushion. The cast iron base measures 419mm (16.5") across and 305mm (12") deep overall and has a black enamel finish.

**\* Includes support rod.**

Description	VWR Cat. No.
Heavy-Duty Support Stand with 457.2mm (18") Rod	<b>60100-105</b>
Heavy-Duty Support Stand with 584.2mm (23") Rod	<b>97035-510</b>
Heavy-Duty Support Stand with 711.2mm (28") Rod	<b>97035-512</b>
Heavy-Duty Support Stand with 914.4mm (36") Rod	<b>97035-514</b>
Heavy-Duty Support Stand with 1016mm (40") Rod	<b>97035-516</b>
Heavy-Duty Support Stand with 1219.2mm (48") Rod	<b>97035-518</b>
Heavy-Duty Support Stand with 1524mm (60") Rod	<b>97035-520</b>

## VWR® Replacement Support Rods

Description	Diameter	VWR Cat. No.
457.2mm (18") stainless steel rod	16mm (0.63")	<b>97039-966</b>
584.2mm (23") stainless steel rod	16mm (0.63")	<b>97035-522</b>
711.2mm (28") stainless steel rod	16mm (0.63")	<b>97035-524</b>
914.4cm (36") stainless steel rod	16mm (0.63")	<b>97039-968</b>
1016mm (40") stainless steel rod	16mm (0.63")	<b>97035-526</b>
1219mm (48") stainless steel rod	16mm (0.63")	<b>97039-970</b>
1524mm (60") stainless steel rod	16mm (0.63")	<b>97039-972</b>

Support Stand



Heavy-Duty Support Stand



# VWR® Talon® Support Stands

Cast iron support stand bases are constructed with black enamel finish. All bases feature a built-in support rod holder with locking knob that accepts a 13mm (0.51") dia. support rod.

\* **Support rods are not included.**

## VWR® Rectangular Base Support Stand, Cast Iron

Description	Dimensions	VWR Cat. No.
Rectangular Base (only)	102 x 152mm (4 x 6")	12985-068
Rectangular Base (only)	127 x 203mm (5 x 8")	12985-070
Rectangular Base (only)	152 x 229mm (6 x 9")	12985-072
Rectangular Base (only)	(203 x 254mm) (8 x 10")	12985-074



12985-070

## VWR® Tripod Base Support Stand, Cast Iron

Description	Diameter	VWR Cat. No.
Tripod Base (only)	152mm (6")	12985-076



12985-076

## VWR® U-Shaped Base Support Stand, Cast Iron

Description	Dimensions	VWR Cat. No.
U-Shaped Base (only)	178 x 178mm (7 x 7")	12985-078



12985-078

## VWR® Aluminum Support Rods

Description	Diameter	VWR Cat. No.
305mm (12") Aluminum Rod	13mm (0.51")	60079-360
457mm (18") Aluminum Rod	13mm (0.51")	60079-381
610mm (24") Aluminum Rod	13mm (0.51")	60079-406
914mm (36") Aluminum Rod	13mm (0.51")	60079-428

## VWR® Stainless Steel Support Rods

Description	Diameter	VWR Cat. No.
305mm (12") Stainless Steel Rod	13mm (0.51")	60079-533
457mm (18") Stainless Steel Rod	13mm (0.51")	60079-534
610mm (24") Stainless Steel Rod	13mm (0.51")	60079-535
914mm (36") Stainless Steel Rod	13mm (0.51")	60079-536



## VWR® Round Support Plate

Aluminum plate supports beakers, mantles, and petri dishes. Fits standard lab-frames using VWR connectors or holders, shown on pages 14-16.

Plate Diameter	Distance from Rod	VWR Cat. No.
152mm (6")	66mm (2.6")	<b>60079-000</b>



60079-000

## VWR® Support Plates

Designed to hold Hotplates/Stirrers and other apparatus to lab-frames or ring stands. Aluminum construction offers strength and durability. Support plates include a non-skid rubber mat and a built-in holder that grips rods up to 19mm (0.75") in diameter.

Size	Plate Dimensions	Distance from Rod	VWR Cat. No.
Small	241 x 165mm (9.5 x 6.5")	48mm (1.9")	<b>11301-124</b>
Medium	324 x 229mm (12.75 x 9")	48mm (1.9")	<b>11301-126</b>
Large	400 x 305mm (15.75 x 12")	48mm (1.9")	<b>11301-128</b>



11301-126

## VWR® Bench Clamp

Aluminum bracket with arm fastens quickly and firmly to any convenient shelf. Accepts 13mm (0.51") rods vertically and horizontally, to which ordinary rings and clamps attach, leaving bench surface clear for apparatus.

Clamp Opening	Depth of Grip	Overall Length	VWR Cat. No.
43mm (1.7")	51mm (2")	197mm (7.75")	<b>60119-001</b>

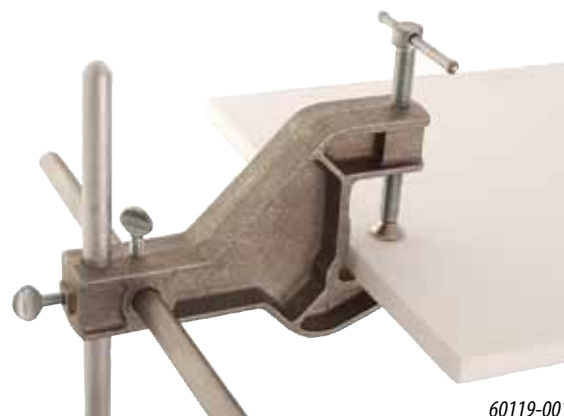

60119-001

# VWR® Cylinder Bench Clamps

Rugged cast aluminum clamps safely secure gas cylinders to benches, tables or other flat surfaces up to 64mm (2.5") thick. The 25mm (1") wide, 1372mm (54") long nylon strap features a nickel-plated, non-slip spring catch and buckle for easy adjustment around cylinders from 102 to 356mm (4 to 14") in diameter. Models 711 and 716 available with or without a "Secure Cylinder" safety message strap.

## VWR® Model 711 Bench Clamp

This bench clamp has a large tightening handle for mounting to any flat surface up to 64mm (2.5") thick. A nylon pad prevents damage to the bench or table surface. Two tapered mounting screw holes are provided for permanent attachment to bench-top.



safety message strap



Description	Dimensions L x W x H (closed)	Cylinder Diameter	VWR Cat. No.
Model 711 Bench Clamp with strap	83 x 133 x 165mm (3.25 x 5.25 x 6.5")	102 to 356mm (4 to 14")	60142-003
Model 711 Bench Clamp with safety message strap	83 x 133 x 165mm (3.25 x 5.25 x 6.5")	102 to 356mm (4 to 14")	97035-528

## VWR® Model 716 Bench Clamp

This bench clamp is similar to Model 711, but includes a sturdy safety chain for extra security. Chain measures 1244.6mm (49").



safety message strap



Description	Dimensions L x W x H (closed)	Cylinder Diameter	VWR Cat. No.
Model 716 Bench Clamp with strap & chain	83 x 133 x 165mm (3.25 x 5.25 x 6.5")	102 to 356mm (4 to 14")	60142-006
Model 716 Bench Clamp with safety message strap & chain	83 x 133 x 165mm (3.25 x 5.25 x 6.5")	102 to 356mm (4 to 14")	97035-530

## VWR® Model 712 Heavy-Duty Bench Clamp

This bench clamp has two screw clamps to tighten for extra firm mounting to any flat surface up to 45mm (1.75") thick with a 32mm (1.25") overhang. Especially convenient for temporary storage situations. Rugged cast aluminum bench clamp features a 25mm (1") wide, 1372mm (54") long nylon strap with nickel-plated, non-slip spring catch buckle to hold cylinders from 102 to 356mm (4 to 14") in diameter. This clamp is not available with a safety message strap.



Description	Dimensions L x W x H (closed)	Cylinder Diameter	VWR Cat. No.
Model 712 Heavy-Duty Bench Clamp with strap	83 x 152 x 114mm (3.25 x 6 x 4.5")	102 to 356mm (4 to 14")	97035-532

## VWR® Model 715 Wall Bracket

Cylinder wall-mount brackets are constructed of cast aluminum and contoured to allow cylinders to fit firmly along the support edge. Recessed screw holes at each side of the bracket allow for easy wall mounting. Features a 25mm (1") wide, 1372mm (54") long nylon strap with nickel-plated, non-slip spring catch and buckle for fast, easy adjustment. Available with or without a "Secure Cylinder" safety message strap. For cylinders from 102 to 356mm (4 to 14") in diameter.



*safety message strap*



Description	Dimensions L x W x H	Cylinder Diameter	VWR Cat. No.
Model 715 Wall Bracket with strap	48 x 206 x 117mm (1.875 x 8.125 x 4.625")	102 to 356mm (4 to 14")	60141-124
Model 715 Wall Bracket with safety message strap	48 x 206 x 117mm (1.875 x 8.125 x 4.625")	102 to 356mm (4 to 14")	97035-534

## VWR® Model 717 Wall Bracket

This wall bracket is similar to Model 715, but includes a sturdy safety chain for extra security. Chain measures 1244.6mm (49").



*safety message strap*



Description	Dimensions L x W x H	Cylinder Diameter	VWR Cat. No.
Model 717 Wall Bracket with strap & chain	48 x 206 x 117mm (1.875 x 8.125 x 4.625")	102 to 356mm (4 to 14")	60141-126
Model 717 Wall Bracket with safety message strap & chain	48 x 206 x 117mm (1.875 x 8.125 x 4.625")	102 to 356mm (4 to 14")	97035-536

# VWR® Cylinder Stands

## VWR® Model 701 PVC Coated Stand

The PVC coated stand has a flat bottom support so it can't "ride up" on the cylinder. Includes an adjustable 25mm (1") wide, 1372mm (54") long nylon strap with nickel-plated, non-slip spring catch and buckle for fast, easy adjustment to keep the cylinder safely in place against upper support bar. Lower support bar stops cylinder shift. The PVC coating prevents marring of the cylinder surface. This clamp is not available with a safety message strap.



Description	Dimensions L x W x H	Cylinder Diameter	VWR Cat. No.
Model 701 PVC Coated Stand	438 x 438 x 273mm (17.25 x 17.25 x 10.75")	178 x 254mm (7 to 10")	60140-998

## VWR® Model 703 Stand

This cast aluminum stand hinges open and has 4 thumbscrews to tightly grip cylinders from 203 to 229mm (8 to 9") in diameter.



Description	Dimensions (Dia. x H)	Cylinder Diameter	VWR Cat. No.
Model 703 Stand	464 x 152mm (18.25 x 6")	203 to 229mm (8 to 9")	97035-538

## VWR® Model 704 Adjustable Stand

Heavy-duty, cast aluminum stand with adjustable "L" brackets holds cylinders from 152 to 235mm (6 to 9.25") in diameter. Hinges open for installation without lifting the cylinder or disturbing connections. Prevents accidental tipping. Hinges open for easy, no-lifting installation.



Description	Dimensions (Dia. x H)	Cylinder Diameter	VWR Cat. No.
Model 704 Adjustable Stand	470 x 191mm (18.5 x 7.5")	152 to 235mm (6 to 9.25")	97035-540

## VWR® Model 713 Portable Stand

This cast iron portable cylinder stand offers a sturdy cylinder stand and a convenient cylinder dolly all-in-one. This cylinder stand is designed in two interlocking halves and can be installed without lifting the tank. Built-in rubber wheels for easy mobility. Three thumbscrews tightly grip cylinder.



Description	Dimensions (Dia. x H)	Cylinder Diameter	VWR Cat. No.
Model 713 Portable Stand	368 x 394 x 76mm (14.5 x 15.5 x 3")	178 x 235mm (7 to 9.25")	60141-000

VWR flow control devices offer selection and quality. They are finely machined to deliver accurate regulation or interruption of fluid flow. Every flow control device resists corrosion and rust. Hosecocks offer easy one-hand operation. Convex bearing surfaces and rounded edges protect tubing. Pinchcocks are designed to quickly start and stop flow and provide complete closure without damaging tubing. Operated with a simple squeeze. Nickel-plated construction.

## VWR® Regular Hosecock

Adjustment screw with oversized head for accurate regulation. Built-in side lugs for foot mounting. Tubing retainer screw.

Min. to Max. Grip	Dimensions (W x H - open)	VWR Cat. No.
0 to 17mm (0 to 0.67")	37 x 62mm (1.46 x 2.44")	<b>21716-102</b>

Stainless Steel		
Min. to Max. Grip	Dimensions (W x H - open)	VWR Cat. No.
0 to 17mm (0 to 0.67")	37 x 62mm (1.46 x 2.44")	89202-614

## VWR® Heavy-Duty Hosecock

Large handwheel for ease of flow adjustment. Unique design offers unparalleled control. Works well with heavy cut nylon braided tubing.

Min. to Max. Grip	Dimensions (W x H - open)	VWR Cat. No.
0 to 29mm (0 to 1.14")	57 x 106mm (2.24 x 4.17")	<b>21704-908</b>

## VWR® Hosecock Extension Clamp

Similar to regular hosecock but with 145mm (5.7") bottom mounted extension rod for attachment to frames/rods. **NOTE:** An additional holder must be purchased in order to attach clamps to frames or other apparatus. See the Connectors & Holders section of this brochure, pages 14-16.

Min. to Max. Grip	Arm Length	Arm Diameter	Overall Length	VWR Cat. No.
0 to 17mm (0 to 0.67")	145mm (5.71")	8mm (0.31")	175mm (6.89")	<b>21716-110</b>

## VWR® Hosecock Foot

Add this option to 21716-102 for bench or table mounting. Includes two mounting screws.

Diameter	VWR Cat. No.
27mm (1.06")	<b>21716-105</b>

## VWR® Regular Pinchcock

For routine stop/start flow operation.

Min. to Max. Grip	Clamp Height	VWR Cat. No.
0 to 12mm (0 to 0.47")	47mm (1.85")	<b>21573-155</b>

## VWR® Variable Flow Pinchcock

For precise flow adjustment and duplication of flow rates.

Min. to Max. Grip	Clamp Height	VWR Cat. No.
0 to 13mm (0 to 0.51")	47mm (1.85")	<b>21573-655</b>

## VWR® Heavy-Duty Pinchcock

Equipped with heavy-duty spring for tough jobs. Ensures complete closure.

Min. to Max. Grip	Clamp Height	VWR Cat. No.
0 to 11mm (0 to 0.43")	48mm (1.89")	<b>21573-650</b>

89202-614



21716-102

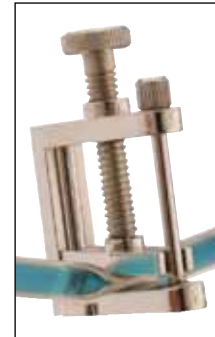

21704-908

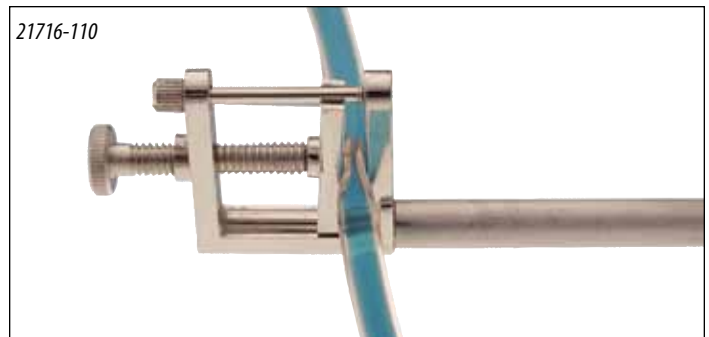



## VWR® Aluminum Lab-Jacks

- **Exceptional stability and durability**
- **Aluminum construction**
- **Three convenient sizes**

Aluminum lab-lifts provide stable height adjustment for various items in the lab such as flasks, baths, and small equipment. Top and bottom decks are constructed of anodized aluminum. Internal supports and drive screws are constructed of stainless steel. Oversized sure-grip adjustment knobs provide smooth and accurate height adjustment. Lab-Jacks accept optional Support Rod Kit which mounts to the upper deck.

12620-904



Deck Size	Min. to Max. Height	Max Load*	VWR Cat. No.
102 x 102mm (4 x 4")	64 to 127mm (2.5 to 5")	29.94kg (66lbs)	<b>12620-900</b>
152 x 152mm (6 x 6")	76 to 248mm (3 to 9.75")	59.87kg (132lbs)	<b>12620-902</b>
203 x 203mm (8 x 8")	89 to 330mm (3.5 to 13")	79.83kg (176lbs)	<b>12620-904</b>
254 x 254mm (10 x 10")	89 to 330mm (3.5 to 13")	84.37kg (186lbs)	<b>10027-578</b>

\* Maximum load rating represents static weight only. Static weight is the amount a unit can hold, not lift.

## Optional Accessory

### VWR® 432mm (17") Support Rod Kit

Ideal for creating an adjustable support stand for mounting various items such as thermometer clamps, temperature probes, flask and column clamps. This kit allows you to mount a 432mm (17") threaded vertical support rod to the upper deck of a 152 x 152mm (6 x 6"), 203 x 203mm (8 x 8") or 254 x 254 (10 x 10") Lab-Lift by screwing the rod into the pre-drilled hole.

Support Rod Kit includes:

- 1 - 432mm (17") stainless steel rod
- 1 - jam nut
- 1 - flat washer

14217-532

Description	Rod Diameter	VWR Cat. No.
Support Rod Kit	13mm (0.51")	<b>14217-532</b>



12620-902

## VWR® Heavy-Duty Lab-Jacks

- **Stainless steel construction**
- **Seven convenient sizes to choose from**
- **Autoclavable and chemical resistant**

These heavy-duty, stainless steel lab-lifts are ultra-stable lifting platforms with exceptional strength and durability. Constructed of 300 series stainless steel, lab-lifts are designed for use in extreme environments and for high load applications. Equipped with over-sized, sure-grip adjustment knobs that provide extra leverage for easy height adjustments. Durable construction allows lifts to be autoclaved or chemically cleaned. Ideal for use in fume hoods or bench tops and holds a variety of items such as glassware, hotplates, baths, and magnetic stirrers.

Deck Size	Min. to Max. Height	Max. Load*	VWR Cat. No.
76 x 76mm (3 x 3")	64 to 127mm (2.5 to 5")	45.36kg (100lbs)	<b>14233-360</b>
102 x 102mm (4 x 4")	64 to 127mm (2.5 to 5")	45.36kg (100lbs)	<b>14233-362</b>
152 x 152mm (6 x 6")	76 to 248mm (3 to 9.75")	60.33kg (133lbs)	<b>14233-364</b>
203 x 203mm (8 x 8")	89 to 330mm (3.5 to 13")	102.97kg (227lbs)	<b>14233-366</b>
254 x 254mm (10 x 10")	89 to 330mm (3.5 to 13")	112.04kg (247lbs)	<b>14233-368</b>
305 x 305mm (12 x 12")	102 to 495mm (4 to 19.5")	45.36kg (100lbs)	<b>14233-370</b>
406 x 406mm (16 x 16")	102 to 495mm (4 to 19.5")	45.36kg (100lbs)	<b>14233-372</b>

\* Maximum load rating represents static weight only. Static weight is the amount a unit can hold, not lift.

## Optional Accessories

### VWR® 432mm (17") Support Rod Kit

Ideal for creating an adjustable support stand for mounting various items such as thermometer clamps, temperature probes, flask and column clamps. This kit allows you to mount a 432mm (17") threaded vertical support rod to the upper deck of a 152 x 152mm (6 x 6"), 203 x 203mm (8 x 8"), 254 x 254mm (10 x 10"), 305 x 305mm (12 x 12"), or 406 x 406mm (16 x 16") Lab-Lift by screwing the rod into the pre-drilled hole.

Support Rod Kit includes:

- 1 - 432mm (17") stainless steel rod
- 1 - jam nut
- 1 - flat washer

### VWR® Ratchet Tool

Designed to add extra leverage to your 305 x 305mm (12 x 12"), or 406 x 406mm (16 x 16") Lab-Lift. This recommended Ratchet Tool easily attaches to the actuating rod to allow easy, accurate adjustments.

Description	Rod Diameter	VWR Cat. No.
Support Rod Kit	13mm (0.51")	<b>14217-532</b>
Ratchet Tool	N/A	<b>14233-232</b>

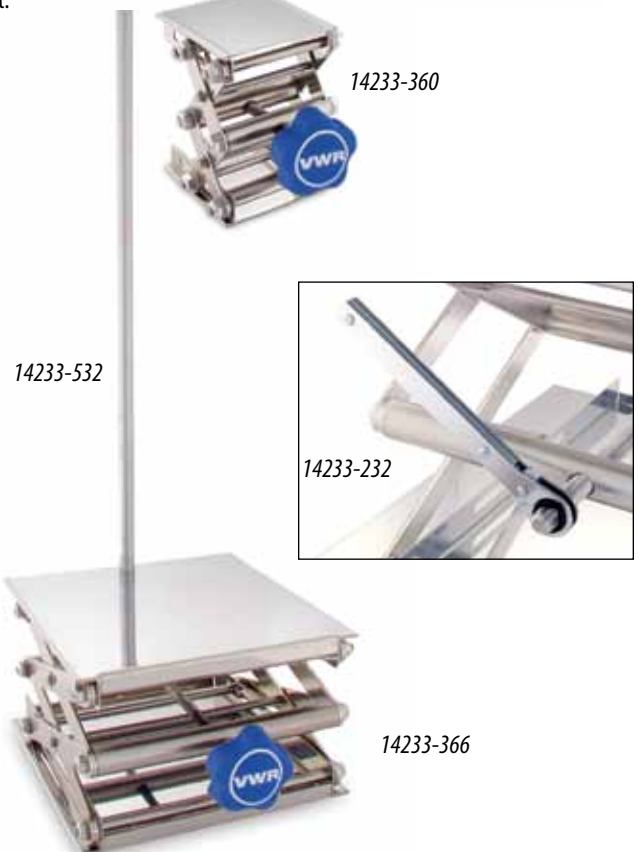
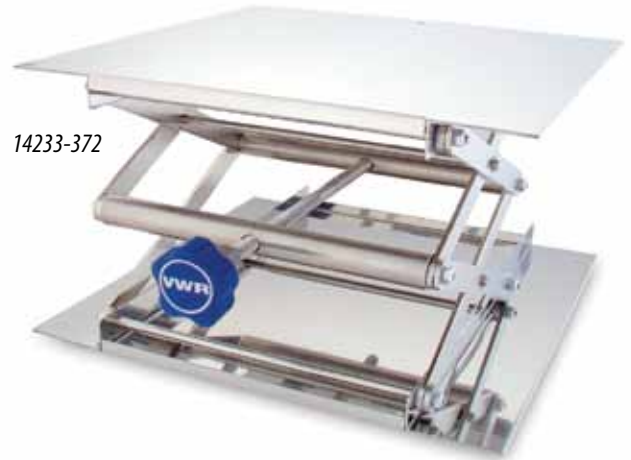



## Other Quality VWR® Products

### VWR® Inoculating Turntables

VWR hand-operated inoculating turntables produce almost concentric circles of bacterial colonies that are evenly distributed across petri dishes. Cast iron turntables are coated with gray baked acrylic enamel.

The 76mm (3") high, small turntable accommodates 100mm petri dishes. It has a tripod base to bring work approximately to eye level. It has a center disk covered with non-skid rubber lining.

The large turntable accommodates 100mm or 150mm petri dishes. It has a height of only 32mm (1.26"), ideal for steadying a forearm on the work surface while plating. The large turntable contains two circular sections. The top section has a raised gripper lip as well as a recessed center disk covered with non-skid rubber lining.

Description	Dimensions (Dia. x H)	VWR Cat. No.
Small Turntable	114 x 77mm (4.49 x 3.03")	50809-022
Large Turntable	150 x 32mm (5.91 x 1.26")	50809-020



50809-022



50809-020

### VWR® Slide Staining Rack

Constructed of stainless steel, the VWR® Slide Staining Rack will resist corrosion under normal use. Adjustable to fit trays or sinks up to 533mm (21") inside.

Description	Dimensions (L x W)	VWR Cat. No.
Slide Staining Rack	603 x 89mm (23.74 x 3.5")	15153-821



15153-821

### VWR® Airejector

Rapid air removal evacuates 1 liter of air to 711mm (28") of vacuum in 30 seconds. Works with compressed air sources to 60 psi. Nickel-plated construction.

Description	Length	VWR Cat. No.
Airejector	140mm (5.51")	28641-001



28641-001

- **Ideal for educational labs**
- **Built-in support rod holder**

VWR® Basic Mini Hotplates, Stirrers, and Hotplate-Stirrers are rugged, compact units that heat and stir up to 1000mL of liquid. Durable, cast aluminum top plate will not crack or chip, and provides an even heating surface. Bi-metallic thermostat offers reliable temperature control. Powerful heater reaches maximum temperature in only minutes. Powerful motor and magnet deliver reliable and consistent stirring. Compact design saves bench space. Built-in support rod holder with locking knob accepts optional Support Rod and Clamp Kit.

Basic Mini Fixed Temperature Hotplate features an illuminated rocker switch to activate the preset fixed temperature of 400°C.

**Operating Features:**

**Adjustment knobs:** Basic speed and temperature control knob with 1 to 10 dial markings.

**Applications:**

Academia, Chemistry 101



Specifications	
Temperature Range	to 400°C *
Speed Range	100 to 1200rpm
Speed Stability	±2%
Maximum Capacity (H <sub>2</sub> O)	1000mL
Top Plate Material	Aluminum
Top Plate Dimension (diameter)	11.4cm (4.5")
Overall Dimensions (L x W x H)	16.5 x 14.6 x 12.1cm (6.5 x 5.75 x 4.75")
Shipping Weight	2kg (4.4lbs)

\* Fixed Temperature Hotplate has a fixed temperature of 400°C.

**Ordering Information**

Units include a 183cm (72"), 3-wire cord and plug (230 volt units are supplied with Euro type plug). Stirrers and Hotplate-Stirrers are supplied with a 3.8cm (1.5") PTFE coated stir bar. 2 year limited warranty on parts and labor. Please visit [www.VWR.com](http://www.VWR.com) for additional colors.

Basic Mini Hotplates		
Description	Electrical (50/60 Hz)	VWR Cat. No.
Basic Mini Hotplate - Ocean Blue	120V   6 amps   565 watts	12621-010
Basic Mini Hotplate - Ocean Blue	230V   2.5 amps   430 watts	12621-016

Basic Mini Stirrers		
Description	Electrical (50/60 Hz)	VWR Cat. No.
Basic Mini Stirrer - Ocean Blue	120V   0.5 amps   20 watts	12620-998
Basic Mini Stirrer - Ocean Blue	230V   0.25 amps   20 watts	12621-004

Basic Mini Hotplate-Stirrers		
Description	Electrical (50/60 Hz)	VWR Cat. No.
Basic Mini Hotplate-Stirrer - Ocean Blue	120V   6 amps   565 watts	12620-986
Basic Mini Hotplate-Stirrer - Ocean Blue	230V   2.5 amps   430 watts	12620-992

Fixed Temperature Hotplate		
Description	Electrical (50/60 Hz)	VWR Cat. No.
Fixed Temperature Hotplate - Gray	120V   6 amps   565 watts	12985-026



1.800.932.5000 | [vwr.com](http://vwr.com)

Prices and product details are current when published; subject to change without notice. | Certain products may be limited by federal, state, provincial, or local regulations. | VWR makes no claims or warranties concerning sustainable/green products. Any claims concerning sustainable/green products are the sole claims of the manufacturer and not those of VWR International, LLC. All prices are in US dollars unless otherwise noted. Offers valid in US and Canada, void where prohibited by law or company policy, while supplies last. | VWR, the VWR logo and variations on the foregoing are registered (®) or unregistered trademarks and service marks, of VWR International, LLC and its related companies. All other marks referenced are registered by their respective owner(s). | Visit [vwr.com](http://vwr.com) to view our privacy policy, trademark owners and additional disclaimers. ©2014 VWR International, LLC. All rights reserved.